

**GRIPS Development Forum  
Policy Minutes**

***Policy Minutes No. 21***

***GRIPS Development Forum***

***January 2007***

---

**Seminars on East Asian Development Experiences and  
the Role of Emerging Donors**

**Feedback Seminar on GRIPS Study**

Managing the Development Process and Aid  
*East Asian Experiences in Building Central Economic Agencies*

**Seminar on FDI Promotion in African Countries**

Strategic Action Initiatives for Economic Development  
*Malaysia's Experiences in FDI Promotion and its Applicability to Africa*

**in Tokyo, Japan (November 8-9, 2006)**

---

## Foreword

The GRIPS (National Graduate Institute for Policy Studies) Development Forum organized two seminars, featuring “East Asian Development Experiences and the Role of Emerging Donors” on November 8-9, 2006.

The main purposes of the two seminars were to: (i) share the interim findings of the GRIPS study on “Managing the Development Process and Aid” that examines the East Asian experiences on institution building and enhancement of development administration, with special attention to the coordination mechanisms of central economic agencies; and (ii) present concrete on-going initiatives to apply the East Asian experiences of FDI promotion strategies in Africa. These seminars were complementary and aimed at discussing the East Asian experiences in development and aid management, as well as investment promotion.

Active discussions took place for both seminars, and we have greatly benefited from valuable remarks and presentations by distinguished panelists and a guest speaker, who have shared country perspectives and their actual experiences in Thailand and Malaysia. In addition, senior Japanese aid practitioners have provided donor perspectives, building on their rich experiences. The GRIPS team sincerely appreciates their cooperation and valuable inputs to the seminars.

We would like to publish the records of these two seminars in the GRIPS policy minutes series to share the content of presentations, issues raised by the panelists, and seminar discussions. These perspectives will be duly taken into account when the GRIPS team finalizes its study paper. The policy minutes consist of two parts:

- Part I: Feedback seminar on GRIPS study:  
“Managing the Development Process and Aid—East Asian experiences in building central economic agencies”
- Part II: Seminar on FDI promotion in African countries  
“Strategic Action Initiatives for Economic Development—Malaysia’s experiences in FDI promotion and its applicability to Africa”

For more details, please visit the website of GRIPS Development Forum:

<http://www.grips.ac.jp/forum-e/research2006/aidmgt.htm> (English)

<http://www.grips.ac.jp/forum/aidmgt/index.htm> (Japanese)

We hope that the two seminars will contribute to deepening discussions on how to concretize and disseminate East Asian experiences in development and aid management and investment promotion to the other part of the world including Africa and the role of emerging donors in these regards.

January 2007

GRIPS Development Forum

## **About the speakers**

### *Seminar on 8<sup>th</sup> November 2006*

- **Ms. Izumi Ohno:**  
Professor / GRIPS  
Specialized in development administration and partnership; ODA policies and reform.
- **Ms. Masumi Shimamura:**  
Associate Professor / GRIPS  
Specialized in international development and economic cooperation policy; development administration and aid coordination.

### *Seminar on 9<sup>th</sup> November 2006*

- **Mr. Jegasothy Jegathesan:**  
Senior Investment Adviser : Consultant to JICA and the Government of Zambia and former Deputy Director General of the Malaysian Industrial Development Authority (MIDA).

## **About the panelists**

### *Seminar on 8<sup>th</sup> November 2006*

- **Mr. Nophadol Bhandhugravi:**  
President of Neighbouring Countries Economic Development Cooperation Agency (NEDA), Thailand.  
Prior to NEDA, he was Deputy Director-General of the Fiscal Policy Office, Ministry of Finance.
- **Mr. Jegasothy Jegathesan:**  
Senior Investment Adviser : Consultant to JICA and the Government of Zambia and former Deputy Director General of the Malaysian Industrial Development Authority (MIDA).
- **Mr. Takeo Matsuzawa:**  
Director General, Development Assistance Department I, Japan Bank for International Cooperation.  
Specialized in Overseas Economic Cooperation Operations to Southeast Asian countries including Thailand, Malaysia and the Philippines.

### *Seminar on 9<sup>th</sup> November 2006*

- **Mr. Aiichiro Yamamoto:**  
Senior Assistant to the Director General, Africa Department of the Japan International Cooperation Agency (JICA).

**GRIPS Development Forum Seminars**  
**East Asian Development Experiences and the Role of Emerging Donors**

**CONTENTS**

**PART I: Feedback Seminar on GRIPS Study: Managing the Development Process  
and Aid *East Asian Experiences in Building Central Economic Agencies***

<b>Program</b> .....	<b>2</b>
<b>Report on the Feedback Seminar on GRIPS Study</b> .....	<b>3</b>
Summary of Presentations .....	4
Comments from the Panelists .....	6
Main Points Discussed (Panel Discussion and Q&A Session) .....	10

**PART II: Seminar on FDI Promotion in African Countries: Strategic Action  
Initiatives for Economic Development *Malaysia's Experiences in FDI  
Promotion and its Applicability to Africa***

<b>Program</b> .....	<b>17</b>
<b>Report on the Seminar on FDI Promoting in African countries</b> .....	<b>18</b>
Summary of Keynote Speech.....	19
Main Points Discussed.....	22

**ANNEXES..... 27**

Annex 1: Presentation materials of Part I (PPTs and Handouts)

1-1 “Study Concept and Diverse Model of Macroeconomic Coordination in East Asia” by Ms. Izumi Ohno.....	29
1-2 “Key Factors Affecting the Effectiveness of Development Administration and Aid Management in East Asian Countries” by Ms. Masumi Shimamura.....	47
1-3 Introduction of the NEDA organization: Forward together with Thailand NEDA .....	63
1-4 “Managing the Development Process and Aid” by Mr. Takeo Matsuzawa.....	69

Annex 2: Presentation materials of Part II (PPTs and Handouts)

2-1 “Strategic Action Initiatives for Economic Development; Strategies for Investment Promotion in Developing Nations” by Mr. Jegasothy Jegathesan .....	70
2-2 Comments by Mr. Aiichiro Yamamoto.....	81



# **PART I**

## **FEEDBACK SEMINAR ON GRIPS STUDY**

## Program

**<Feedback Seminar on GRIPS Study>**  
**Managing the Development Process and Aid**  
*- East Asian Experiences in Building Central Economic Agencies -*

- **Time:** November 8th 2006 (Wednesday), 13:30-16:30
- **Venue:** GRIPS Roppongi Campus, Conference Room 4A (4th floor)

■ **Program:**

- 13:30-13:40 Introduction  
(by Ms. Izumi Ohno, Professor, GRIPS)
- 13:40-14:40 Presentations on the GRIPS study (30 minutes for each)
- ◆ Study Concept and Diverse Models of Macroeconomic Coordination in East Asia  
(by Ms. Izumi Ohno, Professor, GRIPS)
  - ◆ Key Factors Affecting the Effectiveness of Development Administration and Aid Management in East Asian Countries  
(by Ms. Masumi Shimamura, Associate Professor, GRIPS)
- 14:40-14:50 Intermission
- 14:50-15:20 Comments from the panelists (10 minutes for each)
- ◆ Mr. Nophadol Bhandhugravi  
(President, Neighboring Countries Economic Development Cooperation Agency – NEDA, Thailand)
  - ◆ Mr. Jegasothy Jegathesan  
(Senior Investment Adviser, Consultant to JICA and the Government of Zambia and former Deputy Director General of the Malaysian Industrial Development Authority – MIDA)
  - ◆ Mr. Takeo Matsuzawa  
(Director General, Development Assistance Department I, Japan Bank for International Cooperation – JBIC)
- 15:20-16:20 Panel discussions and Questions & Answers  
(Moderator: Ms. Masumi Shimamura)
- 16:20-16:30 Wrap up

# **Report on the Feedback Seminar on GRIPS Study**

## **Managing the Development Process and Aid**

### ***- East Asian Experiences in Building Central Economic Agencies -***

The Feedback Seminar on the GRIPS study about East Asian experiences in building central economic agencies in the areas of development and aid management was the first part of the GRIPS Development Forum Seminars. The main purpose of this feedback seminar was to share with those interested stakeholders the interim findings of the GRIPS study on “Managing the Development Process and Aid” that examines the East Asian experiences in institution building and enhancement of development administration. By doing so, it intended to: (i) promote the understanding of how the East Asian countries (namely Thailand, Malaysia and the Philippines) have managed the development process, integrating aid; (ii) facilitate active discussions on the relevance of bringing these concrete experiences into today’s developing countries including Africa; and (iii) enhance the understanding of the role of emerging donors in East Asia in this regard.

The seminar consisted of three parts. First, the GRIPS study team made two presentations on: (i) the study concept and diverse models of macroeconomic coordination in East Asia by Ms. Izumi Ohno (GRIPS); and (ii) key factors affecting the effectiveness of development administration and aid management in East Asian countries by Ms. Masumi Shimamura (GRIPS). This was followed by the comments and discussions by the three panelists with distinguished professional experiences in development and aid management. These panelists were: (i) Mr. Nophadol Bhandhugravi, President, Neighbouring Countries Economic Development Cooperation Agency (NEDA), Thailand; (ii) Mr. J. Jegathesan, Senior Investment Adviser, Consultant to JICA and the Government of Zambia and former Deputy Director General of the Malaysian Industrial Development Authority (MIDA); and (iii) Mr. Takeo Matsuzawa, Director General, Development Assistance Department I, Japan Bank for International Cooperation (JBIC). Lastly, panel discussions and questions and answers (Q&A) by all the participants took place.

This note provides: (i) the summary of presentations by the GRIPS study team; (ii) comments from the three panelists; and (iii) the main points discussed among the GRIPS study team, the panelists and participants during panel and open discussions.

Approximately fifty aid professionals, including policymakers, practitioners, consultants, researchers and students participated in the seminar. The participants were those interested in the issues on strengthening of development administration and capacity building in developing countries, as well as global debates on aid effectiveness. Active discussions took place over: (i) the role of the private sector and public-private cooperation; (ii) the roles of legislature and politicians (also related to democratization); (iii) decentralization and governance structures; (iv) leadership; and (v) the applicability of East Asian experiences to Africa and the role of donors.

The GRIPS team appreciated valuable inputs and comments provided by the panelists and participants and will make necessary revisions to finalize the study paper.



## Summary of Presentations

### **(1) Ms. Izumi Ohno (Professor, GRIPS)**

#### **“Study Concept and Diverse Models of Macroeconomic Coordination in East Asia”**

The speaker first explained the focus of the analysis and basic premise of the GRIPS study. The study examines Thailand and Malaysia, mainly from the late 1950s to 80s when the current development administration system was formulated and enhanced. It also includes the analysis of the Philippines before and after the turning point of democracy restoration in 1986. A central part of the analysis is the coordination mechanisms of central economic agencies—through such instruments as development plans, budget, public investment and aid management—because they assume a critical role as “strategic core centers” of development management. The study also examines key factors affecting their operations and institution building.

This study endeavours to bring country perspectives and learn from the real experiences of the three East Asian countries. In this respect, the speaker presented the East Asian views of “ownership” (that should be fostered by recipients) by highlighting the three elements that are insufficiently captured in today’s global debates: (i) managing donors and aid, as integral part of the development process; (ii) willingness to graduate from aid, supported by an “exit plan”; and (iii) managing policy ideas, with selectively adopting foreign knowledge.

After explaining the country contexts of the three East Asian countries on macroeconomic and aid management, the speaker gave an overview of macroeconomic coordination mechanisms by central economic agencies and the role of development plan. There exist institutional variations for the design and coordination mechanisms of central economic agencies, including their policy and resource alignment functions. At the same time, the experiences of Thailand and Malaysia suggest that there exist common functional principles that have ensured their operations as strategic core centers. These are a strategic role of development plans, comprehensive enforcement of macroeconomic guidelines, good inter-agency coordination, and commitment and capacity to use aid as integral part of the development process. Also, strong alliance between political leaders and technocrats around shared visions is essential.

The speaker stressed the importance of taking account of the local context when building institutions and argued that donors should be mindful of promoting alignment of their assistance, especially in the countries with weak strategic core functions.

[See Annex 1-1 for PPT and handouts]

**(2) Ms. Masumi Shimamura (Associate Professor, GRIPS)**

**“Key Factors Affecting the Effectiveness of Development Administration and Aid Management in East Asian Countries”**

The speaker examined critical factors that affected the formulation and enhancement of development administration in three East Asian countries, namely, Thailand, Malaysia and the Philippines, by looking into the dynamics of development administration: (i) quality of leadership; (ii) alliance between leadership and technocrats; (iii) fear of external and domestic crises; (iv) degree of political intervention to the “executive branch”; and (v) utilization of aid as integral part of development management. The speaker pointed out that the cumulative synergetic effect of a number of factors had affected the countries’ overall development administration. External factors (both positive and negative) gave major impacts on development administration, and leadership mattered especially at critical stages of development.

The speaker analyzed diverse mechanisms for development planning, investment programming and aid management for each country. The actual coordination features were presented to show how each country organized itself in pursuing priority development goals. The speaker analyzed how each country brought development plans to realization, maintaining coherence among development priorities, public investment planning and aid management. With respect to donor management, the speaker pointed out that both Thailand and Malaysia have strategically and selectively utilized aid toward “graduation”.

The speaker examined the specific case of one of Thailand’s most notable mega-projects, the Eastern Seaboard Development Plan that started in the 1980s to illustrate what major factors contributed to its advance towards success: (i) strong and effective leadership to ensure the public’s interest; (ii) competency of technocrats; (iii) powerful central economic agencies; (iv) special institutional settings; (v) functioning coordination mechanisms; and (vi) external global factors.

Finally, the speaker emphasized the need to understand the country context more carefully when aiming to enhance aid effectiveness because key factors affecting development administration are diverse and such differences should be well taken into account.

[See Annex 1-2 for PPT]

## Comments from the Panelists

### **(1) Mr. Nophadol Bhandhugravi, President, Neighbouring Countries Economic Development Cooperation Agency (NEDA), Thailand<sup>1</sup>**

The first panelist, Mr. Nophadol Bhandhugravi, shared his thoughts on Thailand's development administration, looking back to his own experiences as policymaker. Prior to NEDA, he served for the Fiscal Policy Office (FPO) and the Public Debt Management Office (PDMO) in the Ministry of Finance.

He pointed out the importance of strong leadership, commitment and ownership in order to strengthen country's development administration. He emphasized that, especially for a latecomer country, leaders should provide long-term development vision with strong will and that technocrats in the central economic agencies should translate the vision into action plans by mobilizing various resources and coordinating with various stakeholders including the private sector. He remarked that for most part of Thailand's history, leaders came up with dreams and technocrats translated them into tangible and workable reality.

Mr. Nophadol congratulated the GRIPS team for conducting an excellent study including country analyses and a case study on Thailand's Eastern Seaboard Development Plan. The study has accurate information, with relevant facts and sources that he can hardly argue with. He also acknowledged the importance of examining the roles and responsibilities of each central economic agency, including how they coordinated among themselves, in order to understand Thailand's success. Nevertheless, he made one correction in the GRIPS presentation, suggesting that: (i) the "gang of four" referring to the four central economic agencies should be phrased as the "big four"; and (ii) among the "big four" responsible for development and aid management, the Bureau of the Budget has played a critical role and the Bank of Thailand is not one of the "big four," although it has been a part of various committees for macroeconomic management<sup>2</sup>.

Based on his experiences as policy maker at the FPO, Mr. Nophadol recalled that he has closely worked with the other agencies in handling development management including foreign aid. He confirmed that the Thai government has utilized aid as supplementary resources to fill domestic financial gap, as analyzed in the GRIPS study. He emphasized that Thailand has strived to become self-sufficient, possessing an "exit plan." While utilizing foreign aid, the Thai government endeavored to generate its own resources through FDI promotion and private sector development.

He mentioned that the secret of Thai government's coordination mechanism lies in the informal discussions and consensus-building process. It worked the same way for the Eastern Seaboard Development Plan. In addition to the formal channels such as national committees

---

<sup>1</sup> See Annex 1-3 for introduction of the NEDA Organization.

<sup>2</sup> During the intermission, he clarified that the "big four" consists of the National Economic and Social Development Board (NESDB), the Bureau of the Budget (BOB), the Fiscal Policy Office (FPO), and the Public Debt Management Office (PDMO).

and sub-committees, the Thai government has effectively conducted policy dialogues and coordination informally with the relevant stakeholders including the private sector to come up with important policy decisions.

**(2) Mr. Jegasothy Jegathesan, Senior Investment Adviser, Consultant to JICA and the Government of Zambia, and former Deputy Director General of the Malaysian Industrial Development Authorities (MIDA)**

The second panelist, Mr. Jegathesan, began his comments emphasizing the critical role of leadership in development management. He then raised an issue of donor-driven agenda setting especially in Africa, based on his own experiences as investment adviser in various African countries. He concluded his remark with a concrete suggestion on the key factors that affected the development administration of the three East Asian countries, which was addressed by the GRIPS study.

With regard to the role of leadership, he pointed out that both donor and recipient sides are trident, consisting of: (i) political leadership; (ii) civil service leadership; and (iii) private sector leadership. He raised the following questions to donor and recipient sides to provoke the thinking of "real" motives of leadership, and then emphasized that all these tridents must come together to carry out donor assistance successfully<sup>3</sup>.

<Donor side>

- What is the motive of political leadership in donor countries?—to keep recipient countries totally dependent on donors, or to help recipient countries become self-sufficient and graduate from aid?
- What is the motive of civil service leadership in donor countries?—for example, how much bureaucratic effort has been made to undertake aid activities?
- One can see in many instances “donor fatigue” taking place. But who is at fault. Ostensibly NO ONE for all undertake these programs with a good motive. But what effort is made to ensure that the funds provided are “demand-driven” to meet a real and felt need of the recipient nation and to what extent is the aid “supply-driven” to fulfill an agenda of the donor government?

<Recipient side>

- What is the motive of political leadership in recipient countries?—to use donor money for their own personal interests, or to use it for national development?
- What is the motive of civil service leadership in recipient countries?—are they committed to pursuing efficiency and integrity?
- Do recipients accept whatever donor program is offered even if they do not need this program, for fear that any refusal will “offend” the donor and may affect future funds inflow?

---

<sup>3</sup> The question of the motive of private sector leadership was not raised here, as he was going to cover it in-depth in the seminar next day.

Regarding the issues of donor-driven agenda setting especially in Africa, he emphasized that the critical challenge for donors is to understand the real needs of recipients and work with them closely. Often recipients do not speak up their real demand to donors. They are afraid that donor assistance may be terminated if they dare to speak up. Thus, they prefer to keep quiet.

He also pointed out the significant challenge for donors in helping recipients graduate from aid. He stressed that the idea of recipients' "managing donors" and having "exit plans," as suggested in the GRIPS study, is highly important and that the only solution is to create wealth and jobs through developing private sector dynamism. It is important to develop the private sector as an engine of growth because successful companies generate profits and contribute to tax revenues, which can then be utilized for building a self-sustainable economy; otherwise, recipient countries would be stuck in poverty and continue with aid dependency. In this regard, he appreciated Japan's South-South cooperation proposed at the Tokyo International Conference for African Development (TICAD) process highly important.

He gave one classic example of how Malaysia handled donor management when it used to be aid recipient. The Malaysian government did not necessarily listen to everything what donors suggested. When Malaysia launched the New Economic Policy after the 1969 ethnic riot, every international agency criticized it a "socio-economic engineering" and anticipated its failure. Despite such criticisms, the Malaysian government firmly maintained its policy and successfully overcame the crisis.

Finally, regarding the implications for donors, he supported the point made by the GRIPS study on the need for donors to understand the country context more carefully to enhance aid effectiveness. At the same time, he further suggested that donors make increased effort to assist the countries in establishing an economic environment for creating wealth and jobs by the private-sector.

### **(3) Mr. Takeo Matsuzawa, Director General, Development Assistance Department I, Japan Bank for International Cooperation (JBIC)**

The third panelist, Mr. Takeo Matsuzawa, raised the three points from a donor's perspective: (i) the predictability of development policies, especially from private sector perception; (ii) prioritization on the sector supported by external assistance; and (iii) feedback mechanism of development plans.

With regard to the predictability of development policies, he assessed that both Thai and Malaysian governments have assured their predictability. Especially, the Thai government has been flexible to meet private sector needs. A good example was the government's response to the Eastern Seaboard Development Plan. Also, the Thai government's policy in promoting security markets and long-term banking facilities for private sector development had good effects on the country's development programs. In the case of Malaysia, the government has firmly demonstrated policy continuity, and dared to make huge investments such as super corridors. Moreover, the Malaysian government, in comparison with the other countries, has shown the real capacity of implementation.

By comparison, he noted that development policies had been less predictable in the Philippines. Every time government changed, policy also changed. So, there was lack of policy consistency, and the predictability for project implementation was hardly secured. In this regard, he stated that the discussions on the Philippines' ongoing efforts to improve policy predictability might be useful for other developing countries including Africa.

Regarding prioritization for external assistance, he stated that in Thailand, JBIC and the former Overseas Economic Cooperation Fund (OECF)<sup>4</sup> could easily identify and support Thai government's strategic priorities. Developing road networks (both national and rural) is a good example, and the government duly considered and specified criteria, such as improvement of income distribution and alleviation of urban-rural disparities. In the case of Malaysia, the government has prioritized particular sectors to encourage foreign direct investment—for example, power generation in the peninsular—although foreign aid is not sought for funding all requirements of the private sector. Such way of prioritization contributed to attracting more private sectors.

He also shared his thoughts on the feedback mechanism in Thailand looking back to the 1980s when Dr. Saburo Okita<sup>5</sup> dispatched policy dialogue missions to Thailand. The Thai government revised previous Mid-term Development Plans every five years and shared their vision with Japan. As such, there was no need for the Japanese government to make intervention at the micro-level (e.g., small programs and projects). He recalled that such policy dialogue had facilitated aid relationship between Japan and Thailand.

[See Annex 1-4 for the outline of his comments]

---

<sup>4</sup> The current JBIC took over the Official Development Assistance (ODA) loan operations of the OECF in 1998.

<sup>5</sup> As a leading economist at the ex-Economic Planning Agency, Dr. Okita made significant contribution to realizing Japan's post-war economic recovery and growth. Later, he served as the President of ex-OECF during 1973-77, as well as the Minister of Foreign Affairs during 1979-80.

## **Main Points Discussed (Panel Discussions and Q&A Session)**

The discussions focused on the following issues: (i) the role of the private sector and public-private cooperation; (ii) the roles of legislature and politicians (also related to democratization); (iii) decentralization and governance structures; (iv) leadership; and (v) the applicability of East Asian experiences to Africa and the role of donors. Many of the issues raised (especially (i)-(iv)) are related to the scope, direction, and basic premise of the GRIPS study. The discussions benefited a lot by the contributions of the three panelists, who provided their concrete experiences of Thailand and Malaysia in managing the development process and aid—either from a recipient side or a donor side.

### **(1) The role of the private sector and public-private cooperation**

Several participants noted the importance of analyzing the role of the private sector and public-private cooperation. For example, one participant suggested that while the GRIPS study primarily focused on the role of the government (especially, central economic agencies), it should also pay attention to the role of the private sector because the private sector served as the other side of the coin in achieving shared growth. Thailand and Malaysia both have had strong business associations (e.g., Thai Chamber of Commerce, Federation of Malaysian Manufacturers), and without these professionally managed associations, the role of the government would have been weak. According to him, the role and capacity of business associations in the Philippines were relatively weak indeed. He also shared his findings that although some former socialist countries in East Europe (e.g., Poland, Czech, Hungary) had strong leadership, super-ministries, and good coordination mechanisms in the 1970s and 80s, business associations and the private sector had very limited roles in their economies. Another participant stated that the experiences of Thailand and Malaysia in strengthening public-private sector consultation process might be relevant to African countries. He suggested that the analysis of how these governments had established coordination mechanisms and networks with the private sector in 70s and 80s would enrich the GRIPS study.

Mr. Jegathesan commented on the role of the private sector in Malaysia, looking back to its historical evolution. After 1969, throughout the 70s and early 80s, no prominent private sector existed in Malaysia, and there was not single manufacturing factory. So, the country was purely driven by the government and civil service leadership at the time. However, within ten years (from 1970 to 80), Malaysia succeeded in promoting export industries. It was only after the mid-1980s, during Prime Minister Mahathir's administration, that the Federation of Malaysian Manufacturers (FMM) and the chamber of commerce had become stronger and that many of the industries associations (e.g., rubber and electronic industry associations) had created think tanks to give recommendations to the government. Thus, the local private sector became part of the think tanks, which facilitated policy coordination between public and private sectors. He added that now the private sector was very much part of the government's strategic thinking in development administration.

While fully acknowledging the important role of the private sector in the development process, the GRIPS team clarified that this study intended to focus on intra-government coordination

mechanisms and aid management and that the detailed analysis of the private sector's role would be beyond its scope. The GRIPS team recognizes the complementary role between the government and private sector. This is why the study attempts to analyze the functions and coordination mechanisms of the central economic agencies which could importantly affect the private sector's role and capacity, through such instruments as development planning, public investment selection, and macroeconomic management (to create an economic environment conducive to private sector activities).

## **(2) The roles of the legislature and politicians (also, related to democratization)**

Strong interests were shown on the treatment of the executive-legislative relationship, including the role of politicians, in the GRIPS study. A participant commented that while the study seemed to treat the legislative intervention into the executive branch (in the case of the Philippines) negatively, many developing countries today were experiencing the democratization process where the legislature tended to gain stronger power in decision-making. Therefore, the more balanced view could be taken to examine the role of legislature in development management. Another participant also suggested the importance of analyzing the issues on: (i) capacity building of politicians; and (ii) the role of the parliaments in Thailand and Malaysia during the 70s and 80s, as compared with that of the Philippines. While the study analyzes the role of politicians in the Philippines in a negative context, this may not be the case for Sub-Saharan African countries. The role of politicians in Sub-Saharan Africa may be considered more positively since they are making efforts to strengthen their capacity, and external pressure from donors is also generating momentum.

The GRIPS team agreed on the importance of the ongoing democratization process in many developing countries. It also shared that legislative intervention itself should not be viewed in a negative context because the legislature is expected to provide check and balance functions in policy decisions. Nevertheless, the GRIPS team stressed that the important point was whether the whole nation, including politicians, had a shared, united vision for development. In the case of the Philippines, despite the central government's effort to formulate and realize national development priorities from holistic and comprehensive viewpoints, respective politicians have their own specific interests (often attached to local constituencies) which are apart from national development priorities. Because they propose projects that have nothing to do with public investment priorities ("pork barrel"), such intervention may lead to inefficiency and create allocative distortion. It is this circumstance—the absence of a shared development vision across the executive and legislative branches—that political interventions may become problematic.

A participant supplemented the GRIPS team's explanation from a public financial management viewpoint. He stated that the problem with the "pork barrel" was that the government could not handle the entire inflow of funds because such funds allocated to each legislator were not subject to the government's scrutiny. In other words, legislators try to insert additional projects and programs, displacing those that have originally received high priorities in the public investment programs.



Mr. Jegathesan stressed the vital importance of capacity building of politicians. Although many people discuss capacity building of civil servants and the private sector, the political capacity building is most crucial. This is one of the important lessons he has learned from his ongoing work in Zambia<sup>6</sup>. Unless political leaders at the local and regional levels understand the direction and reasons for promoting development, they will protest and complain about development policies. Because all political leaders are not economic literates, capacity building at the political level is essential to make them understand why economic development and FDI promotion are important. This is the first crucial task toward strengthening political will.

### **(3) Decentralization and governance structures**

Active discussion took place on decentralization and various levels of governance structures, and the actual decentralization experiences in Thailand and Malaysia were also shared. One participant pointed out that the study seemed to examine development administration in East Asia in the 1970s and 80s, mainly in light of their role and functions in managing infrastructure development rather than service delivery. However, as many countries face the challenge of expanding and improving service delivery, the study should pay greater attention to the analysis of governance structure including the sub-national government, the private sector, and NGOs. Otherwise, this study may have limited relevance and applicability to today's developing countries.

The GRIPS team appreciated his comments and stated that it fully recognized the importance of service delivery and that such functions might be better served by the decentralized, local government or other actors. Nevertheless, the team stressed that this study gave importance to the policies that promote growth and consequently, development administration in support of formulating and implementing growth promotion policies. In this regard, larger-scale public investments play a vital role, and the functions and coordination mechanisms for development planning, investment prioritization, resource mobilization become a central part of the analysis.

Then, a participant explained the ongoing decentralization process in Indonesia and asked how the government (especially local and regional governments) should strengthen their capacities for development planning and investment programming. Other questions were also raised regarding different governance structures between Thailand (centralized unitary state system) and Malaysia (federal state system) at both central and sub-national levels and their implications for institution building in today's developing countries.

Mr. Jegathesan explained that Malaysia's federal system has had important advantages in promoting development. The country has thirteen states. Each state became the engine of growth, and as a result, thirteen engines of growth have been created. Many of the development programs have been state-led, and the federal government provided financial support. Although decentralization/devolution had not been a planned initiative in Malaysia, under the federal system, each state had to push forward its development agenda and compete among them to achieve economic development.

---

<sup>6</sup> Mr. Jagathesan is currently involved in South-South Cooperation for Investment Promotion. Please see the Part II of this policy minutes for the details.

Mr. Matsuzawa stated that although Thailand and Malaysia had been decentralized, their central economic agencies still had important roles. These agencies would set the basic direction of development in the national development plans, and under such basic direction, the local governments would incorporate respective local needs and make necessary modifications. If everything is decentralized and every plan is to be prepared by the local governments, the scarcity of human resources and capacity would become bottlenecks. As such, JBIC attaches great importance to coordination between the central economic agencies and local governments. This point is discussed in details in a recent study: ADB-JBIC-World Bank on East Asia and Pacific Infrastructure Flagship Study<sup>7</sup>.

A participant asked how the study incorporated the analysis of corruption because this issue had increasingly attracted attention in the governance agenda. The GRIPS team responded that the study did not analyze the issue on corruption *per se* and rather tried to consider the governance issues in relation to the ownership concept. The study also takes account of the point made by Prof. Yasutami Shimomura (Hosei University) in his discussion paper<sup>8</sup>, which argues that although Thailand did not score highly on the internationally available governance indices in the 1970s and 80s even compared with Africa and other countries, it has achieved remarkable economic development. While corruption can be a critical factor affecting development administration, this may not be the only factor to take account. In other words, the other factors must be also considered. For these reasons, the GRIPS study primarily focuses on intra-government coordination mechanisms and alignment functions in view of development planning, budgeting, investment selection, aid management, and so on.

#### **(4) Leadership**

A participant asked for the conceptual clarification of the “quality of leadership” used in the GRIPS study. More specifically, the study discusses the “quality of leadership” as one of the key factors affecting development administration and stresses the importance of strong leadership. But, it is also possible to regard dictatorship as strong leadership. Therefore, it is necessary to clarify this concept, especially about the differences between strong leadership and dictatorship.

The GRIPS team explained that strong leaders were not necessarily effective leaders. A good example is the comparison between President Marcos in the Philippines and Prime Minister Prem in Thailand. Although both were strong leaders, Prime Minister Prem was generally regarded as a strong and effective leader. President Marcos deployed cronies around him who exercised strong power to maintain his dictatorship and to secure his own interests. On the other hand, Prem had sound vision and dedication to ensure the public’s interest for the benefit of the whole country. To put it simply, effective government is a subset of the bigger category of strong government since strong government is not necessarily effective. Consequently, strong and effective government may have good leadership.

---

<sup>7</sup> *Connecting East Asia: A New Framework for Infrastructure*, Asian Development Bank, Japan Bank for International Cooperation, and the World Bank, 2005.

<sup>8</sup> “The Role of Governance in Development Revisited: A Proposal of an Alternative View” (2005) Discussion Paper on Development Assistance No.5, FASID International Development Research Institute.

Mr. Jegathesan stressed that leaders should not be confined to Prime Ministers and Presidents and that this matter should be considered from a broader perspective. There are three categories of officials that constitute leaders: (i) Prime Ministers and Presidents; (ii) Ministers of government ministries; and (iii) Permanent Secretary and head of departments with the ministries (mainly, civil servants). Whereas politicians and ministers ((i) and (ii)) come and go, civil servants ((iii)) hold permanent jobs. So civil servants assume important role. Problems occur when the inferior and mediocre people occupy the more superior positions than those truly capable and superior. Only when the truly superior people occupy the superior positions, dynamic development would take place. Therefore, the challenge of leadership is how to position people so that the superior people can occupy the superior positions.

#### **(5) The applicability of East Asian experiences to Africa and the role of donors**

Several questions were raised on the applicability of East Asian model to Africa. One participant asked which country case—among the three East Asian countries (Thailand, Malaysia and the Philippines)—would be most relevant to the current African context. The other participant wished to know specific ways how the experiences in Thailand and Malaysia could be applied to African countries today. The panelists shared respective views based on their experiences. Discussions also developed into the role of donors in supporting African development, including possible improvement of current aid approach.

Mr. Nophadol responded that there would be no “one size fit all” panacea and that development management must be conducted, by taking account of the country-specific context.

Mr. Jegathesan also stated that the applicability of East Asian model(s) should be considered selectively, for example, by specific sector, rather than nationwide. The African situations are different from those of East Asia, and in fact, there is no Asian success model for a land-locked country. He also pointed out that the problems also existed on the donor side and that donors must improve their aid-giving practices. His working experiences with the top government officials in Africa (including the governments of Uganda, Zambia, Senegal and Ghana) suggest that they are all competent and knowledgeable about the bottlenecks respective countries face. Although donors tend to tell these governments “what” to do, they already know the problems and bottlenecks. So, donors should rather advise the governments “how” to do on the ground, by step by step. This is the critical challenge for donors, and many donors have failed to take such approach.

From a donor perspective, Mr. Matsuzawa stressed that flexibility would be more important than applying any specific East Asian model(s) to Africa. For long, Japan has been conducting annual consultations with the recipient countries in East Asia to closely discuss their development priorities and the issues on planning and implementation of ODA projects. Such continuous, annual consultations seem to have helped Japanese policymakers and aid practitioners to deepen their understanding of recipients’ priorities and country-specific problems and to take flexible approach when adjustments are needed. However, in the case of Africa, it is difficult for Japan (especially, the ODA loan operations) to conduct annual consultations with recipient countries due to the resource constraints on the Japanese side. If Japan wishes to apply its aid approach (which has been extended to East Asia for long) to

Africa, it would become necessary to focus its assistance on a few countries in Africa instead of supporting every country in an equal manner.

A participant from the Embassy of Thailand, who has working experiences with various donors during financial crises in the late 1990s, stated that Japan's "partnership approach" was a very good practice. At that time, Japan held consultations with the Thai government, respecting its ownership. She stressed the vital importance for donors to consider recipient's real needs when providing assistance.



## **PART II**

### **SEMINAR ON FDI PROMOTION IN AFRICAN COUNTRIES**

## Program

**<Seminar on FDI Promotion in African Countries>**  
**Strategic Action Initiatives for Economic Development**  
*- Malaysian Experiences in FDI Promotion and Its Applicability to Africa -*

- **Time:** November 9th 2006 (Thursday), 13:30-16:30
- **Venue:** GRIPS Roppongi Campus, Conference Room 3C (3th floor)

- **Program:**

- |             |   |
|-------------|---|
| 13:30-13:40 | Introduction<br>(by Ms. Izumi Ohno, Professor, GRIPS)   |
| 13:40-15:10 | Keynote Speech on FDI promotion initiatives in Africa (90 minutes) <ul style="list-style-type: none"><li>◆ Strategic Action Initiatives for Economic Development: Strategies for Investment Promotion in Developing Nations<br/>(by Mr. Jegasothy Jegathesan, Senior Investment Advisor, Consultant to JICA and the Government of Zambia and the former Deputy Director General of the Malaysian Industrial Development Authority – MIDA)</li></ul> |
| 15:10-15:20 | Intermission  |
| 15:20-15:30 | Comment (10 minutes) <ul style="list-style-type: none"><li>◆ Mr. Aiichiro Yamamoto<br/>(Senior Assistant to the Director General, Africa Department, Japan International Cooperation Agency – JICA)</li></ul>   |
| 15:20-16:20 | Free discussions<br>(Moderator: Ms. Masumi Shimamura, Associate Professor, GRIPS)   |
| 16:20-16:30 | Wrap up   |

# **Report on Seminar on FDI Promotion in African Countries**

## **Strategic Action Initiatives for Economic Development**

### **- Malaysia's Experiences in FDI Promotion and Its Applicability to Africa -**

The Seminar on FDI Promotion in African Countries was the second part of GRIPS Development Forum Seminars on “East Asian Development Experience and the Role of Emerging Donor.” The main purpose of this seminar was to present concrete on-going initiatives to apply the Asian experiences in FDI promotion to Africa. Successes of Asian countries, such as South Korea, Thailand, and Malaysia in FDI-led economic development, suggested some lessons for African countries to solve their today’s social and economic issues.

The seminar consisted of: (i) keynote speech by Mr. Jegasothy Jegathesan—Senior Investment Adviser, Consultant to JICA and the Government of Zambia and the former Deputy Director General of the Malaysian Industrial Development Authority (MIDA)—on Malaysia’s experiences in FDI promotion and its applicability to Africa; (ii) comments by Mr. Aiichiro Yamamoto—Senior Assistant to the Director General, Africa Department, JICA; and (iii) questions and answers by all participants.

After introductory remarks by Professor Izumi Ohno, Mr. Jegathesan presented his empirical experiences in investment promotion of Malaysia in the 1970s and 1980s as well as its applicability to Africa. He also introduced the *Triangle of Hope* (TOH) Program currently being implemented by JICA and the Government of Zambia under the framework of the South-South Cooperation Program, where he provides advisory service as an expert. Followed his presentation, Mr. Aiichiro Yamamoto from JICA gave comments on the presentation and supplemental information on how JICA has been supporting Africa in the areas of local industry development.

Approximately forty professionals participated in the seminar, including policy makers, practitioners, consultants, researchers and students. Active discussions took place over: (i) the applicability of Asian experiences into Africa, (ii) African growth challenges (especially in the globalized economy); and (iii) the importance of an “exit strategy” for African countries to overcome aid dependency and the vital role of leadership in this regard.

The seminar has also confirmed the usefulness of South-South Cooperation Program, including “Asia-Africa Knowledge Co-creation Program.” The participants appreciated the speaker, the panelist and the GRIPS team for sharing their experiences and views, as well as providing an opportunity to discuss the African development in an open and objective manner, based on the concrete, on-going initiatives.



## Summary of Keynote Speech

**Mr. Jegasothy Jegathesan, Senior Investment Adviser, Consultant to JICA and the Government of Zambia, and former Deputy Director General of the Malaysian Industrial Development Authorities (MIDA)**

**“Strategic Action Initiatives for Economic Development: Strategies for Investment Promotion in Developing Nations”:**

Mr. Jegathesan’s presentation is built on his own professional experiences of realizing Malaysia’s industrial success over thirty years, as the former Deputy Director of MIDA, and also on his ongoing advisory service for Zambia’s investment promotion. The speaker first explained Malaysia’s experiences in industrialization in the 1970s and 1980s, drew lessons for African countries from these experiences, and then introduced his current activities and experiences in cooperation with the Zambian government to implement strategic action initiatives for African economic development through South-South Cooperation Program of JICA.

### **(1) Malaysia’s experiences in industrial development**

After race riots in 1969, the Malaysian government launched the first, twenty-year Outline Perspective Plan (OPP) from 1970 to 1990 and the New Economic Policy (NEP) to solve racial imbalance in wealth distribution. The main objectives of OPP and NEP were to create jobs and wealth and to redistribute income and opportunities within the context of a rapidly expanding economy. Ten years after the implementation of the plan and policy, in 1980, Malaysia transformed from a raw material producer into the world-largest producer of electronic semiconductors and the third-largest exporter of room air conditioners. The successful experiences of Malaysia, which could be useful for African countries, were summarized in what the speaker called *Triangle of Hope*, *Quadrant Strategy*, and *Strategic Action Initiative*.

*Triangle of Hope* (TOH) is a symbol of the harmony among three forces of a nation, namely, (i) political will & integrity, (ii) civil service efficiency & integrity, and (iii) private sector dynamism & integrity. In Malaysia, all the three forces had same mindset, shared a same strategic vision and worked together to achieve the national goals. The existence of such harmony is crucial and prerequisite to development undertakings. However, it is not enough for ensuring long-term prosperity and economic stability. For this, “pull factors” that will absorb flows of FDI, not as a little, occasional dribble, but as a wave, are needed. These pull factors make up the essence of the *Quadrant Strategy* for investment promotion, and in fact, Malaysia implemented such strategy to attract FDI and achieved economic growth. The first step in this process is to create an attractive environment for general and specific sectors (*environment*); secondly, identify projects/industries those have comparative and competitive advantages (*projects/industries*); thirdly, promote and build national images to attract inflow of investment (*promotion*); and finally, implement the approved projects as speedily as possible to provide the much needed jobs and wealth within country (*implementation*). The investment environment created by Malaysian government could be described in a simple

formula, namely *Strategic Action Initiative* (SAI):

$$E + C_4 + O = P$$

where, P: Profits for enterprises and Prosperity for the nation

E: Environment

C<sub>4</sub>: Cost and Convenience of doing business, Capability of the environment to sustain dynamic growth, and Concessions

O: Opportunities

Regarding the environment (E), the speaker stressed the ten check-points that every investor would consider before investing in a nation, including: (i) political stability, (ii) economic fundamentals, (iii) attitude of welcome, (iv) government policies, (v) infrastructure, (vi) human resources (vii) banking and finance, (viii) government bureaucracy, (ix) local business environment, and (x) quality of life. Here, “incentives” were not taken into account because, according to him, these ten check points would be fundamental to attract competitive and profitable companies. Just giving government’s incentives without these checkpoints might end up with inviting less competitive companies.

## **(2) Lessons for Africa’s investment promotion**

Based on the experiences of Malaysia, the speaker drew some useful lessons for African countries to promote FDI. The first lesson is the role of *leadership*. Leaders must empower the people with the vision so all feel that this was part of their vision and all want to be part of the mission to realize the vision. According to him, leaders should not be limited to president, prime minister or ministers, but also include senior government officials and parliamentarians.

The second lesson is the importance of strengthening *competitive advantage* because comparative advantage is not enough. Thirty years ago, Malaysia was in the same position of Africa in term of economic backwardness, but now it has become a center for business excellence. The reason for Malaysia’s success lies in the creation of its competitive advantages through the implementation of TOH, Quadrant Strategy and SAI. The speaker indicated that the weakness of African countries in the implementation of Quadrant Strategy was their excessive focus on *promotion* without the sufficient preparation for the *environment* and *projects/industries*. Moreover, *implementation* tends to receive lower priority, compared to project approval. In this regard, he emphasized the role of the National Investment Promotion Agencies (IPA) as a key element in the SAI formula. But he also stressed that the IPA was only the arrowhead; by itself it could not hit any target. Thus, there is a need to build close coordination among policy and law makers, all government departments involved in economic development, the private sector, and IPA to achieve the goals. Based on Malaysia’s experiences, what is needed is not emotional nationalism, but the *Strategic Action Initiatives* (SAI) to design short-, medium-, and long-term targets.

Another major lesson is the *impact of globalization*. The speaker stressed the need to recognize the three great waves that are currently driving the economies of nations: (i) agricultural development, which is slow but provides a continuous drive; (ii) industrial development based on competitive advantage; and (iii) service/knowledge-based industry.

African countries must do specific analyses and find out which sector(s) and wave(s) should be followed in order to gain respective competitive advantage.

### **(3) Ongoing JICA-supported South-South Cooperation Program (between Malaysia and Zambia)**

Finally, the speaker introduced a concrete example of “the Strategic Action Initiatives for Economic Development in Africa,” based on the ongoing South-South Cooperation Program by JICA, for which he works as a consultant.

According to him, although many aid programs were implemented in Africa, there was no single success story so far that others could emulate. Unlike Asia, economic model(s) for African success stories is yet to be established. To meet such challenge, he proposed that three successful models for African countries be selected, consisting of: (i) a model for land-locked nations; (ii) a model for nations with coastline and relative large population; and (iii) a model for island nations. Among the three models, JICA chose the model of land-locked nations—namely, Zambia—and has initiated the implementation of the SAI under the framework of South-South Cooperation Program. A Memorandum of Understanding (MOU) was signed between JICA and the Government of Zambia in March 2005 to launch a “Triangle of Hope” Program (the name of the South–South Cooperation Program in Zambia).

The program has been strongly supported by the Zambian government including the President, as well as parliamentarians. A Presidential Steering Committee chaired by a Deputy Secretary to the Cabinet has been set up to monitor the implementation of the program. Twelve task forces including governmental and private sectors have been formed to examine the issues related to the physical and administrative infrastructure (corresponding to the environment and implementation in *Quadrant Strategy*) and sectors that would have competitive advantage (corresponding to projects/industries in *Quadrant Strategy*). All recommendations made by these task forces regarding agricultural development, cotton industry, human resource development, health care, information and communication technology (ICT), tourism, small- and medium-enterprises (SMEs) and so on were approved by the Cabinet. The program is now moving to the stage of promotion and implementation. Investment seminar will be organized in Malaysia at the end of November 2006, and a visit by Malaysian Investment Mission to Zambia is planned for March 2007. The similar promotion activities are expected to be carried out in the other Asian countries in the second quarter of 2007.

The speaker believed that if all went as planned and all recommendations of the task forces were fully implemented, Zambia would experience increases in FDI and joint ventures in the next two and three years, that should bring jobs and wealth for the Zambian people.

[See Annex 2-1 for PPT]

## **Main Points Discussed**

### **Initial Comments from the Panelist**

#### **Mr. Aiichiro Yamamoto, Senior Assistant to the Director General, Africa Department of the Japan International Cooperation Agency (JICA)**

As the panelist, Mr. Aiichiro Yamamoto shared his views and the information on JICA's activities in support of economic development in Africa. His comments focused on the three issues: (i) the role of Asia-Africa cooperation and the replicability of Asian success models; (ii) trade and investment in the current globalized economy; and (iii) African growth challenges.

Firstly, regarding the replicability of Asian success models into Africa, Mr. Yamamoto stated that a simple copy would not work and that the African people must solve their problems by learning from the Asian experiences by themselves. This is why JICA has been implementing the "Asia-Africa Knowledge Co-creation Program (AAKC)" to promote cooperation between Asia and Africa and to help African countries to solve their problems in an African way, by using the Asian experiences. Under the AAKC approach, JICA initiated last year a Rural Community Development Program between Thailand and African countries to share Thailand's experiences in rural development with the African countries.

Secondly, he questioned a feasibility of trade- and investment-led development in the current globalized economy, stating that FDI would not be the only solution across Africa. Because of the accelerating globalization and increasing pressure for economic integration, African countries could not simply follow the same path that the Asian Tigers had gone through in the 1970s-80s. In addition, there exists a big gap across African countries in attracting FDI. So far, FDI has concentrated in only those countries with rich oil and mineral resources, such as Angola, Sudan, and Mozambique.

Finally, he discussed African growth challenge. There might be a certain limit if African countries try to prepare for economic growth only through FDI in the same fashion as Asia did in the 1980s. African countries should also consider utilizing non-traditional, endogenous and local resources more effectively rather than depending on exogenous resources, such as large-scale foreign investment. Even in the globalized economy, there are still niches in local and domestic markets where small businesses could find their ways to market and sell their products. For example, "one village one product" movement in Malawi supported by JICA is now becoming an engine of local economic growth because through this, Malawi farmers have learned how to market their products and how to take part in the supply chain in domestic markets. He suggested that Africa's growth should be achieved not only by promoting large-scale foreign investment, but also by stimulating local and domestic economies through value adding to local resources and local marketing. In conclusion, he stressed that the success of Africa would not be brought in from outside, but could come from inside.

[See Annex 2-2 for handout]

## **Free Discussions**

The discussions evolved around the following three issues: (i) the applicability of Asian experiences into Africa; (ii) African growth challenges (especially in the globalized economy); and (iii) the importance of an “exit strategy” for African countries to overcome aid dependency and the vital role of leadership in this regard.

### **(1) Applicability of Asian experiences into Africa**

Several participants questioned the applicability of Asian experiences into Africa because the two continents differ significantly in terms of people, culture and history. A participant agreed with Mr. Jegathesan on the vital importance of leadership in driving economic success of a country, but also argued that it was difficult for many African countries to get long-term visions and strong commitments from leaders, politicians and parliamentarians because their political terms were often short. Based on his experiences in working in Kenya for many years, he expressed a feeling that it would be very difficult to draw up a successful case in Africa.

While acknowledging the political difficulties in Africa, Mr. Jegathesan reiterated his belief that a success story could be made in Africa. In fact, JICA’s South-South Cooperation Program, which is currently being implemented in Zambia and known as the “Triangle of Hope” (TOH) Program, is moving in this direction. This program has received strong commitment from the President himself and established a strategic vision that has been widely shared by the Parliament as well. As part of the JICA’s cooperation program, Mr. Jegathesan undertook briefings to Zambia’s Parliament and Cabinet members and witnessed the existence of their political support and coalition toward implementing this program. Now, the TOH program has moved to the stage of implementing the recommendations made by twelve taskforces. While recognizing the challenges ahead, Mr. Jegathesan stressed that the TOH program enjoyed strong support and ownership by the Zambian authorities including the private sector and that he was hopeful of its success.

Mr. Yamamoto also gave an example in Malawi to complement Mr. Jegathesan’s point on the importance of leadership. The “one village one product” program in Malawi got strong commitment from the (previous) President. So, during his terms, the President had already established the structure of program implementation at administrative levels. This has secured the program’s continuity even after the recent change of President. Thus, Malawi’s “one village one product” program enjoys the continued implementation under the new leadership.

Another participant stated that it would be difficult for Africa to apply the Asian experiences due to the historical differences between the two continents. Asia is unique because many Asian countries received cultural influences by China and India. Prior to colonization, their indigenous societies had achieved a certain degree of maturity, possessing their own knowledge and technologies. This might have facilitated the process of their absorbing, adapting and internalizing Western technologies into their local contexts. However, African countries are more diverse and went through dynamic changes. These might have made them more difficult to establish their own basic technologies, which could have been utilized when those countries attempted to absorb and internalize the modern technologies.

Mr. Jegathesan responded that the differences in culture and history were not decisive factors for successful economic development, citing Malaysia as a good example in this regard. In the colonial period and right after dependence, the international society had a pessimistic view on Malaysia's future. The prevailing view at that time was that the country would never be suitable for industrialization because the Malaysian people were lazy and the economy depended heavily on agriculture. But thanks to leaders' vision and commitments of the people concerned, Malaysia transformed completely. He reiterated that he was hopeful of Zambia's successful future, although it faced many problems at this moment.

## **(2) African growth challenges**

A participant from the Embassy of Zambia thanked Mr. Jegathesan for giving great hope for the country through his invaluable cooperation and advice to the Zambian authorities. He explained that Zambia had enjoyed 42 years of peace since independence and thus its political environment was more stable than in Kenya. At the same time, recognizing the fact that the Zambian economy remains heavily dependent on agriculture and agribusiness, he questioned whether Zambia could develop knowledge-based industries and how Zambia could get support from JICA to conduct "one village one product" movement.

Regarding knowledge-based industries, Mr. Jegathesan provided the detailed explanation of the activities and recommendations of twelve taskforces. According to their ideas, Zambia should and could develop knowledge-intensive industries, such as educational industry, health care service, tourism, and information and communication technology (ICT) because these "third wave" industries can build a basis for a center of business excellence and present a promising opportunity for land-locked countries like Zambia in the age of globalization.

Mr. Yamamoto explained that One Village One Product Movement (OVOP) was multi-faceted and implemented at different levels. He further went on to say that OVOP consisted of three categories: (i) the program basically targeted at export industries in large scale, (ii) the "overall movement for small-scale industries" targeted more rather than small groups of farmers, and (iii) the "one village one product movement" targeted at community-based groups. According to his analysis, largely in Africa, the third category is more applicable, especially in agriculture-based countries like Malawi, Ghana, Kenya and Zambia. However, it should be adapted to the country-specific context and demand. He encouraged the Zambian government to contact and discuss this matter more in depth with the JICA office in Zambia, if the government was interested.

Another participant worried about the fiscal constraints faced by many African countries. Given the fact that wages and salaries accounted for the most part of Zambia's budget and little room was left for developmental activities, he questioned whether the task forces of the TOH program made any request for budget allocation and how the Zambia government could get financial sources to implement their recommendations.

Mr. Jegathesan responded that the government had allocated some budgets every year for the taskforces. Because the cabinet secretariat knows about the program, they have allocated enough funds for each task force's activities. The task forces also include private business

sector. In addition, the government also made a brief report to the donor community to ask for their support. He noted that the donors should provide aid based on the countries' demand to help create jobs and wealth. On the other hand, the recipient countries should also build up an "exit strategy" to develop quickly and get out of aid dependence.

A participant questioned how far Malaysia's New Economic Policy (NEP) has succeeded in raising competitiveness of the Bumiputra Malaysian people. He wondered whether and to what extent the Bumiputra Malaysian people, after having received many preferential treatments under the NEP, have become competent compared to the non-Bumiputra Malaysian. Because many African countries are multi-racial and face racial problems, it is very important to know whether African countries can learn from Malaysia's experiences to solve racial issues.

Mr. Jegathesan explained that the results of the NEP should be evaluated holistically, considering all aspects, not only discussing the situation of the Bumiputra people. General speaking, the NEP did not discriminate against any race in the economic activities. The Chinese and Indian Malaysian were not disturbed at all in conducting their businesses. Nevertheless, the international society at that time was quite skeptical about the NEP, calling it as a "socio-economic engineering" exercise. Mr. Jegathesan stressed that overall the NEP had played a critical role in fostering a strategic and shared vision for unified Malaysia, contributed to overcoming the racial crisis in 1969, and provided the basis of today's prosperity. About the applicability of Malaysia's experiences in solving race riots, Mr. Jegathesan said that each country had its unique racial situation and must resolve the problem by its own way.

### **(3) Importance of an "exit strategy" to overcome aid dependency and the vital role of leadership in this regard**

Throughout his presentation and free discussions, Mr. Jegathesan repeatedly emphasized that developing countries, including Africa, should establish and implement an "exit strategy" to get out of aid dependency. Each country must formulate a strategic and shared vision for creating jobs and wealth. Poverty eradication should be considered in the context of a rapidly expanding economy; otherwise, there is a risk that countries might end up with distributing poverty nationwide. Leadership based on the coalition across key politicians, civil servants, and private sector is vital in this regard. This is the essence of "*Triangle of Hope*" program, which is based on Malaysia's nation building experiences.

# **ANNEXES**





Slide 1

# Managing the Development Process and Aid

Study Concept and Diverse Models of  
Macroeconomic Coordination in East Asia



GRIPS Development Forum  
Izumi Ohno  
November 8, 2006

Slide 2

## Outline of Presentation

---

1. About the GRIPS study  
--Focus of the analysis, basic premise
2. Country contexts: Thailand, Malaysia and the Philippines
3. Overview of macroeconomic coordination of central economic agencies (CEAs) in three East Asian countries
4. Synthesis

Slide 3

## 1. GRIPS Study: Focus of the Analysis

### <Issues>

- Coordination mechanisms of central economic agencies (CEAs)
  - Role of Development Plan (DP) in policy and resource planning, alignment functions;
  - Budget and public investment planning;
  - Aid management
- Key factors affecting CEA effectiveness: the role of leadership, technocrats, etc.

Slide 4

## Coordination Mechanisms of CEA

### Policy & resource planning, alignment functions

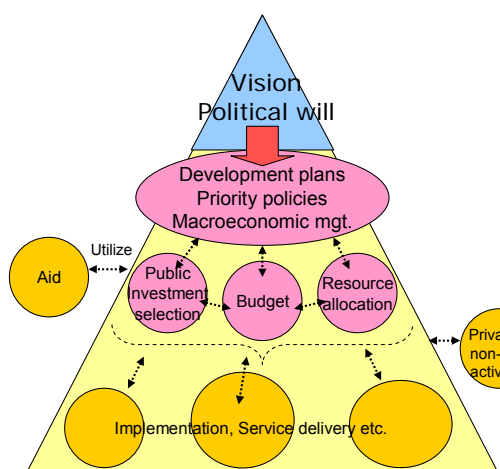

### Key actors affecting CEA functions

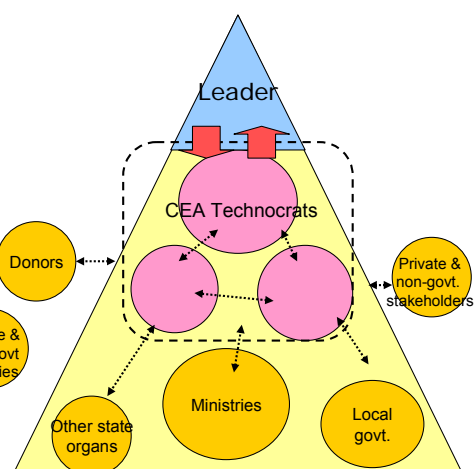

Slide 5

## **GRIPS Study: Focus of the Analysis**

---

### **<Countries>**

- Thailand and Malaysia (late 50s-80s)
  - Building institutional basis for “developmental” CEAs
  - Mobilizing resources and organizing for development; achieving structural transformation (esp. 70s-80s)
  - New emerging donors
- The Philippines (esp. late 80s-)
  - Mixed experiences under the Marcos era;
  - Now, renewed effort for CEA building after democracy restoration in 1986 (“turning point”)

Slide 6

## **GRIPS Study: Basic Premise**

---

- Emphasis on country perspectives
  - “Real” experiences, rather than “ideal” prescriptions
  - No standardized, donor-driven approach to institution building
- Critical role of CEAs in managing the development process
- East Asian views of “ownership”

Slide 7

## GRIPS Study: Basic Premise

---

### <Critical Role of CEAs>

- Economic cases for central administration (Bardhan 1997)
  - Policy coordination in the presence of scale economies
  - Inter-jurisdictional externalities, with spillover effects across localities
  - Support to local administration
- Complementary to decentralized administration
- Providing the enabling environment for private sector development

Slide 8

## GRIPS Study: Basic Premise

---

- “*Developmental*” role of CEAs (Johnson, Haggard, Evans, Wade, etc.)
  - Agent of managing the transformative, development process (Leftwich 1995)
  - *Strategic core centers*:
    - Aligning policy planning and resource mobilization with attaining strategic priorities
    - Coordinating different interests of various stakeholders (domestically and externally; vertically and horizontally)

Slide 9

## GRIPS Study: Basic Premise

### <East Asian Views of "Ownership">

- Managing donors and aid, as integral part of the development process
- Willingness to graduate from aid, supported by an "exit plan"
- Managing policy ideas, with selectively adopting foreign knowledge

(Shimomura and I. Ohno 2005)

- Thailand and Malaysia (esp. 70s-80s): demonstrating East Asian "ownership".
- The Philippines (esp. late 80s-) : currently making effort to establish it.

Slide 10

## Development Management and Aid

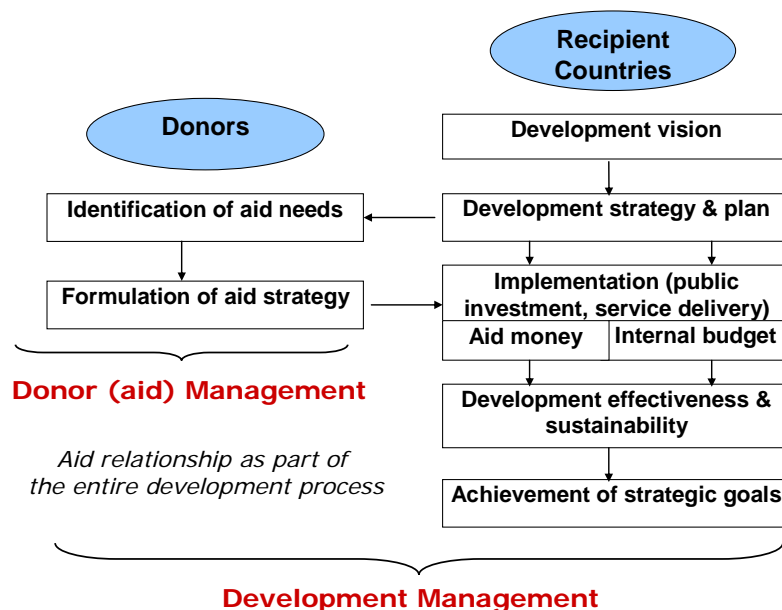

Source: Adapted from I. Ohno and Niiya (2004)

Slide 11

## 2. Country Contexts

### <Socio-Economic Indicators>

	GNP per capita (\$)		Annual growth rate (%) per capita GNP avr. 1965-90	Poverty ratio (%) 1980-90 avr.
	1976	1990		
South Korea	670	5400	7.1	16
Malaysia	860	2300	4.0	27
Thailand	380	1420	4.4	30
The Philippines	410	730	1.3	58

Sources: World Development Report (1976, 92, 93) and Human Development Report (1992)

Slide 12

## Country Contexts: Macroeconomic and Aid Management (→ see Handouts)

Thailand	<ul style="list-style-type: none"> <li>■ Strong fiscal discipline; prudent debt management</li> <li>■ Active, but selective use of aid; changes in aid mix and “graduation”</li> </ul>
Malaysia	<ul style="list-style-type: none"> <li>■ Fiscal activism to support large development expenditures; overall balanced economic management</li> <li>■ Selective use of aid; changes in aid mix and “graduation”</li> </ul>
The Philippines	<ul style="list-style-type: none"> <li>■ Problems of allocative efficiency; heavy debt burden constraining development expenditures</li> <li>■ Active use of aid continuing; selectivity?</li> </ul>

Slide 13

### 3. Overview of CEA Macroeconomic Coordination Mechanisms

<Points>

- ❑ What are the role and functions of CEAs in three East Asian countries?
- ❑ How have macroeconomic coordination mechanisms worked?, What are key actors?
- ❑ What is the role of development plans (DPs) in policy and resource alignment (i.e., budget, public investment selection, aid)?
- ❑ What are implications for building effective CEAs?

Slide 14

### Overview of Macroeconomic Coordination Mechanisms

	Thailand (esp.70s-80s)	Malaysia (esp.70s-80s)	The Philippines (late 80s-now)
Role of CEAs in development mgt.	■Strategic core centers	■Strategic core centers	■Strategic core centers?
Features of macroeconomic coordination	■Centralized, but responsibility shared among four CEAs ■Subtle check & balance	■Centralized, under super-ministry (EPU) ■Multi-layered, rule-based coordination	■“Dual track” (the executive vs. the legislature) ■Insufficient, inter-agency coordination
Role of DPs	■Guiding policy alignment with development priorities, under annual fiscal scrutiny	■Guiding policy & resource alignment with development priorities ■DPs as action plan to achieve LT vision	■Limited policy & resource alignment with DPs
Enforcement of macro-guidelines	■Comprehensive (incl. ODA, SOEs)	■Comprehensive (incl. ODA, SOEs)	■Limited, with exemptions



Slide 15

## 3-1. Thailand: CEA Functions and Key Actors

- Centralized power in the four economic agencies (“gang of four”)
  - NESDB (National Economic & Social Development Board): PM's Office
  - BOB (Bureau of the Budget): PM's Office
  - FPO (Fiscal Policy Office) + PDMO (1999-): MOF
  - Bank of Thailand: central bank
- Leadership: empowering technocrats to plan and administer economic policies
  - Technocratic insulation from political interventions
- Role of CEA technocrats
  - Strong inter-agency coordination; shared responsibility
  - Enforcing legal limits for fiscal deficits and external borrowing

(But, sector-level coordination not necessarily strong)

Slide 16

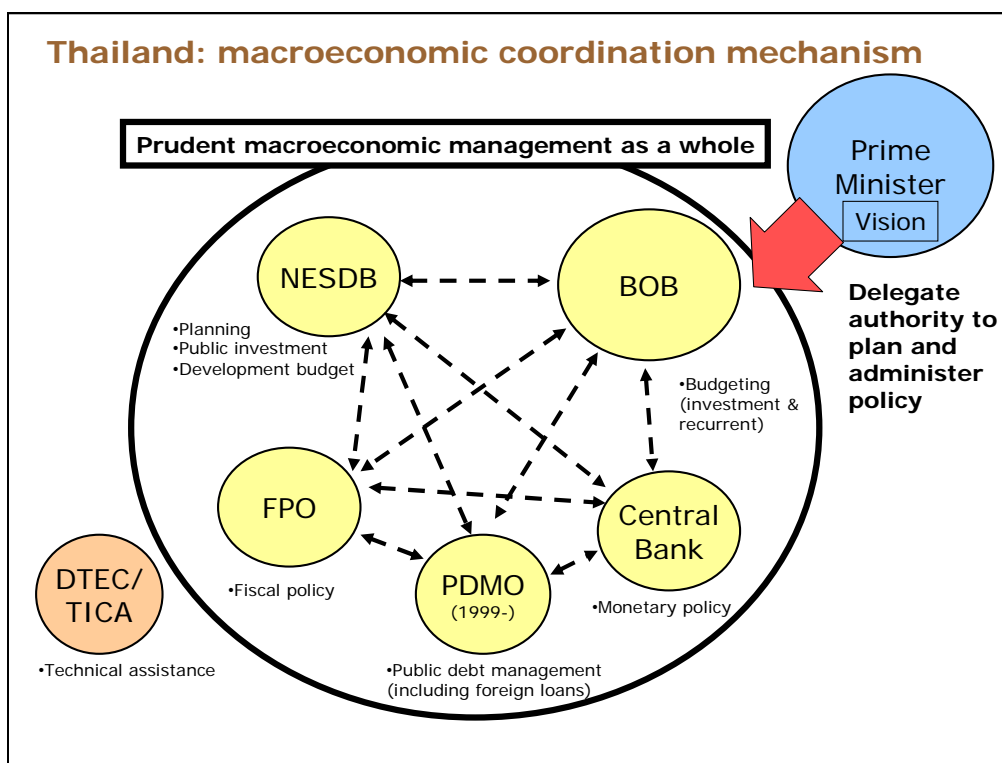

Slide 17

## Thailand: Role of DP in Policy and Resource Alignment

---

- Indicative DPs, without budget implications
- Development priorities clearly indicated in DPs
  - ODA utilization strategy included (esp. 60-70s).
- Flexibility in medium-term planning, while scrutinizing all projects in the annual budget & debt approval decisions
  - BOB “mobile units” providing vertical link to line agencies, through the annual budget process.
  - National Debt Policy Committee; National Committee on State Enterprises.
- Consultation with the private sector (from the 70s, strengthened in the 80s)

Slide 18

## 3-2. Malaysia: CEA Functions and Key Actors

---

- Centralized power in Prime Minister's Dept. (EPU as super-ministry)
  - EPU (Economic Planning Unit): PM's Dept.
  - ICU (Implementation Coordination Unit): PM's Dept.
  - MOF (Ministry of Finance) and Central Bank
- Strong political leadership, providing long-term visions and direction for changes
- Role of CEA technocrats
  - Technical arms to realize PM's visions (esp. New Economic Policy or *Bumiputra* policy in the 70-80s)
  - DPs and budgets as rolling plans to achieve long-term visions

Slide 19

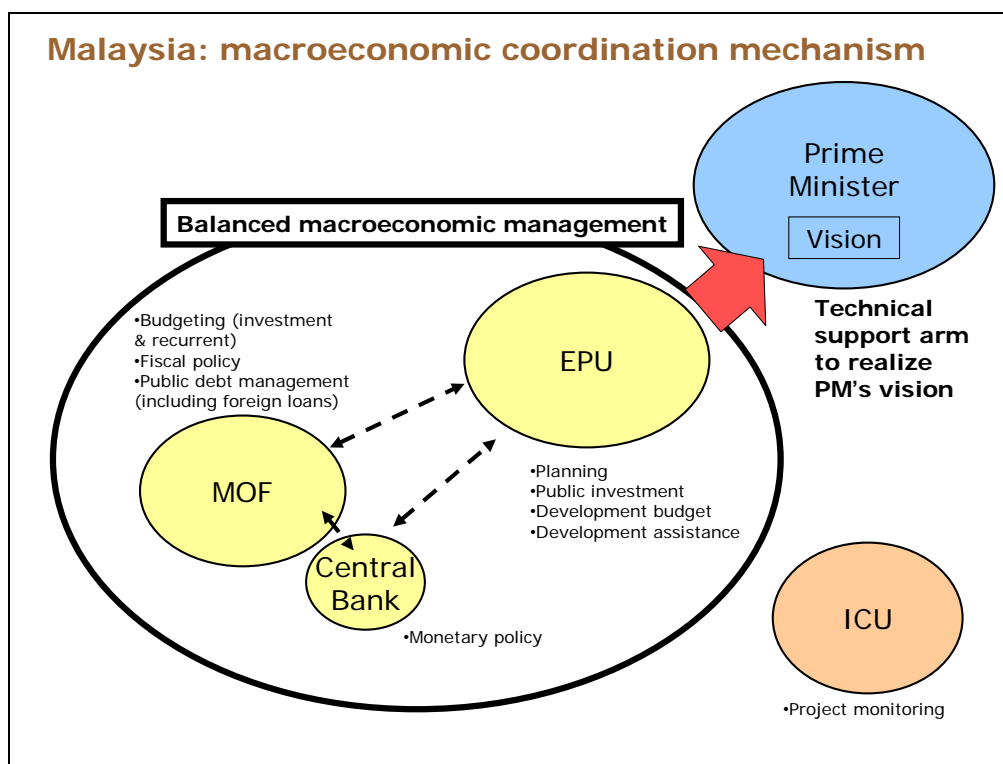

Slide 20

## Malaysia: Role of DP in Policy and Resource Alignment

- ❑ Directive DPs, with budget implications
- ❑ Development priorities and resource allocation clearly indicated in DPs
  - Enforcing budget and sector ceilings for the plan period, while adjusting at mid-term review
  - ODA utilization strategy included in DPs (from the 60s and later expanded as int'l cooperation strategy)
- ❑ Multi-layered, inter-agency coordination for planning and implementation to ensure coherency
  - National Planning Committee, National Action Committee (as apexes); "top-down" and "bottom up" coordination
  - Role of the "planning cells" technocrats -- macro-sector links
- ❑ Consultation with the private sector: e.g., annual budget dialogue (from the 80s)

Slide 21

### 3-3. The Philippines: CEA Functions and Key Actors

- “Dual track” system: executive channel vs. congressional interventions
- President-led NEDA Board (leadership?)
  - NEDA (National Economic & Development Authority)
  - DBM (Dept. of Budget Management)
  - DOF (Dept. of Finance)
  - Central bank
- Cabinet-level, inter-agency coordination bodies (incl. Development Budget Coordination Committee)
  - Effort to synchronize DP, Public Investment Plan (PIP), and annual budget; MTEF introduced in 2003.
  - Effort to strengthen supervision of GOCCs (Govt. Owned and Controlled Corporation), esp. on budget and debt approval.

Slide 22

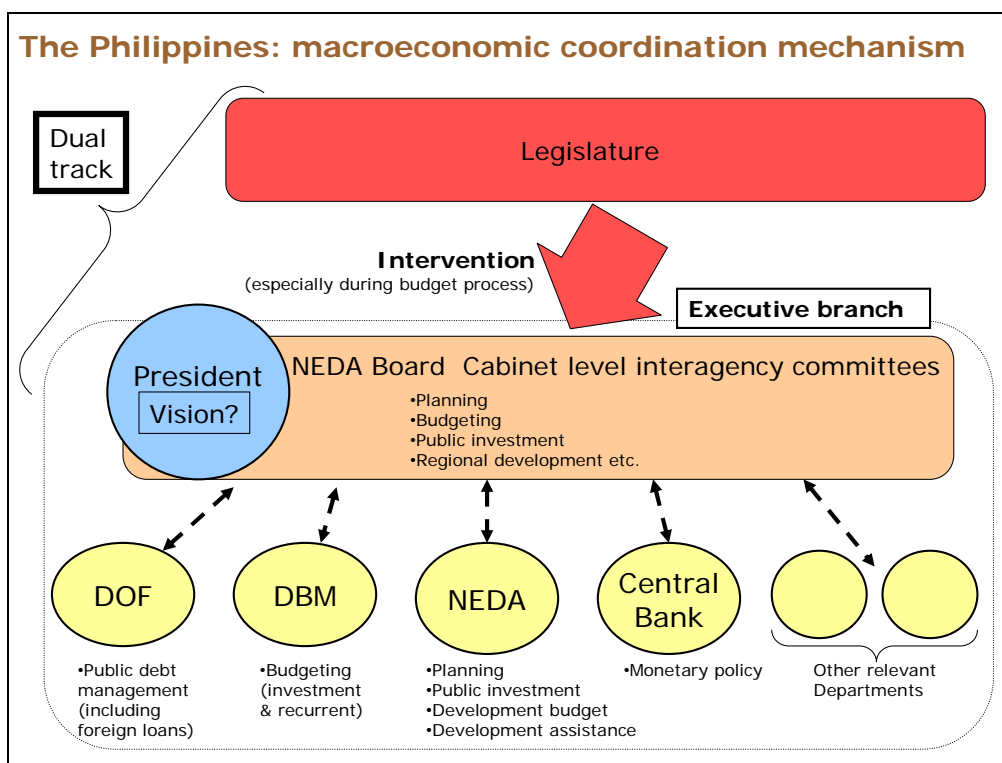

Slide 23

## The Philippines: Role of DP and Macroeconomic Coordination Features

---

- Limited role of DPs in policy planning and resource alignment
  - No budget ceilings for DP and PIP
  - Strategy for ODA utilization and private sector collaboration unclear (until recent DP)
- Weak enforcement of macroeconomic guidelines
  - Large GOCCs exempted from ceiling of Foreign Borrowing Act
  - Vigorous appraisal and monitoring procedures, applied only for ODA and BOT projects
  - Congressionally initiated projects ("pork barrel" funds) outside the regular budget process
- Congressional interventions in the annual budget process, undermining the Executive efforts of DPs-PIP-budget synchronization

Slide 24

## 4. Synthesis

---

- Importance of strengthening CEAs as strategic core centers of development management
- Diverse models of macroeconomic coordination in three East Asian countries
  - Institutional variation for CEA design and coordination mechanisms
  - Need to take account of the local context when building effective CEAs

→ Donors should be mindful of promoting alignment of their assistance, especially in the countries with weak strategic core functions.

Slide 25

## Synthesis

---

- The Philippines:
  - Building “formal” institutions is not sufficient to ensure their effective operations.
  - Importance of the political environment – its interplay with leadership, technocrats, and CEA operations.
  - Role of aid? – enclave, or an entry point for the broader institutional reforms?
- Thailand and Malaysia:
  - Despite differences, they share common “functional” principles to ensure CEA effectiveness.

Slide 26

## Synthesis: Thailand and Malaysia

---

### <Differences>

- Leadership style and operating principles of CEAs
- Degree of DPs binding medium-term resource allocation and project selection

### <Similarities – “functional” principles>

- The content of DPs is strategic enough to serve as the core document for policy alignment
- Comprehensive enforcement of macro-economic guidelines

Slide 27

## **Synthesis: Thailand and Malaysia**

---

- Good inter-agency coordination to ensure policy and resource alignment with development priorities -- within CEAs, plus between CEAs and line agencies
- Commitment and capacity to use ODA, as integral part of the development planning, budget and investment planning processes
- Strong alliance between political leadership and CEA technocrats around shared visions

*The END*

### Selected Fiscal Indicators (Percentage of GDP)

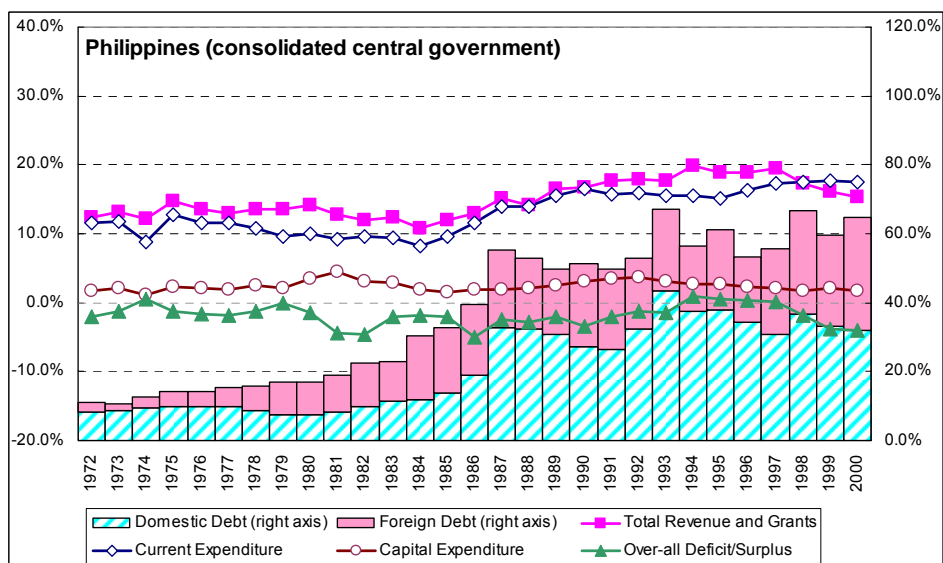
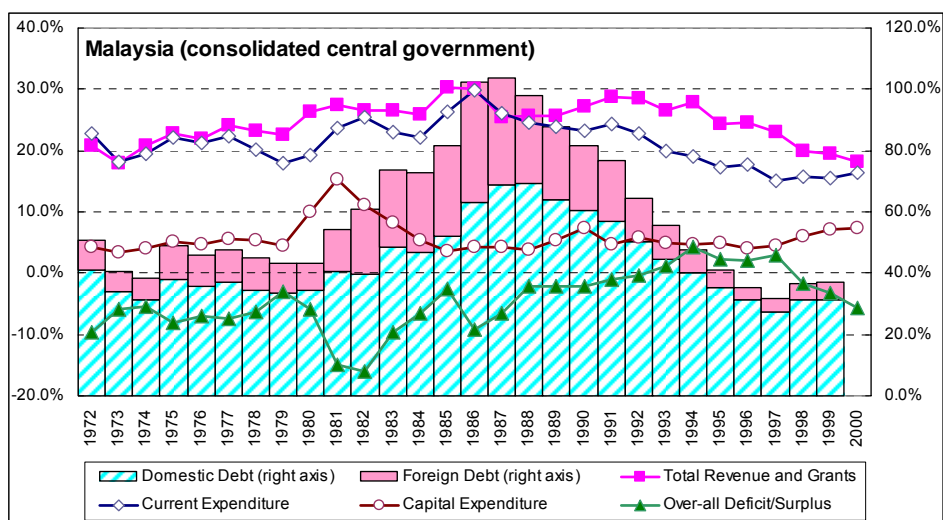
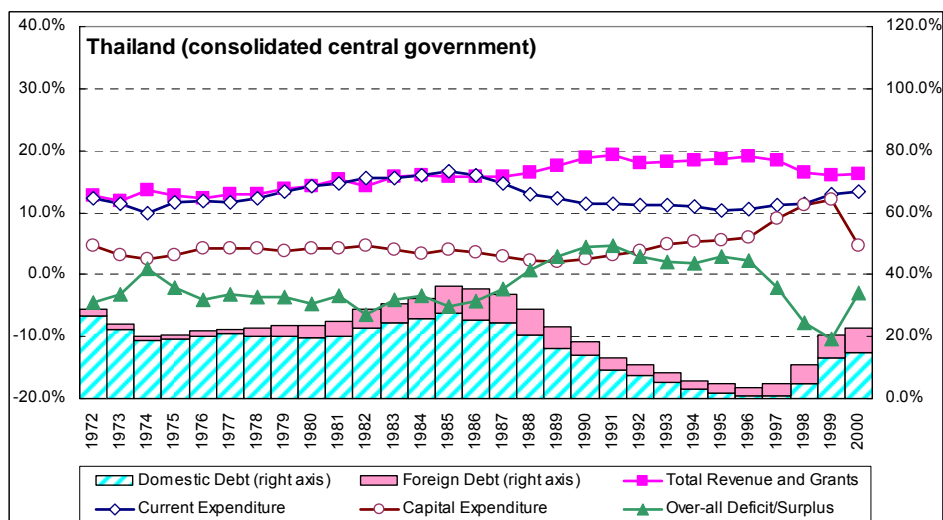

Source: IMF, *Government Finance Statistics Yearbook* (various years), *International Financial Statistics* (various years) and ADB, *Key Indicators of Developing Asian and Pacific Countries* (various years).



### Mobilization of Official Development Finance

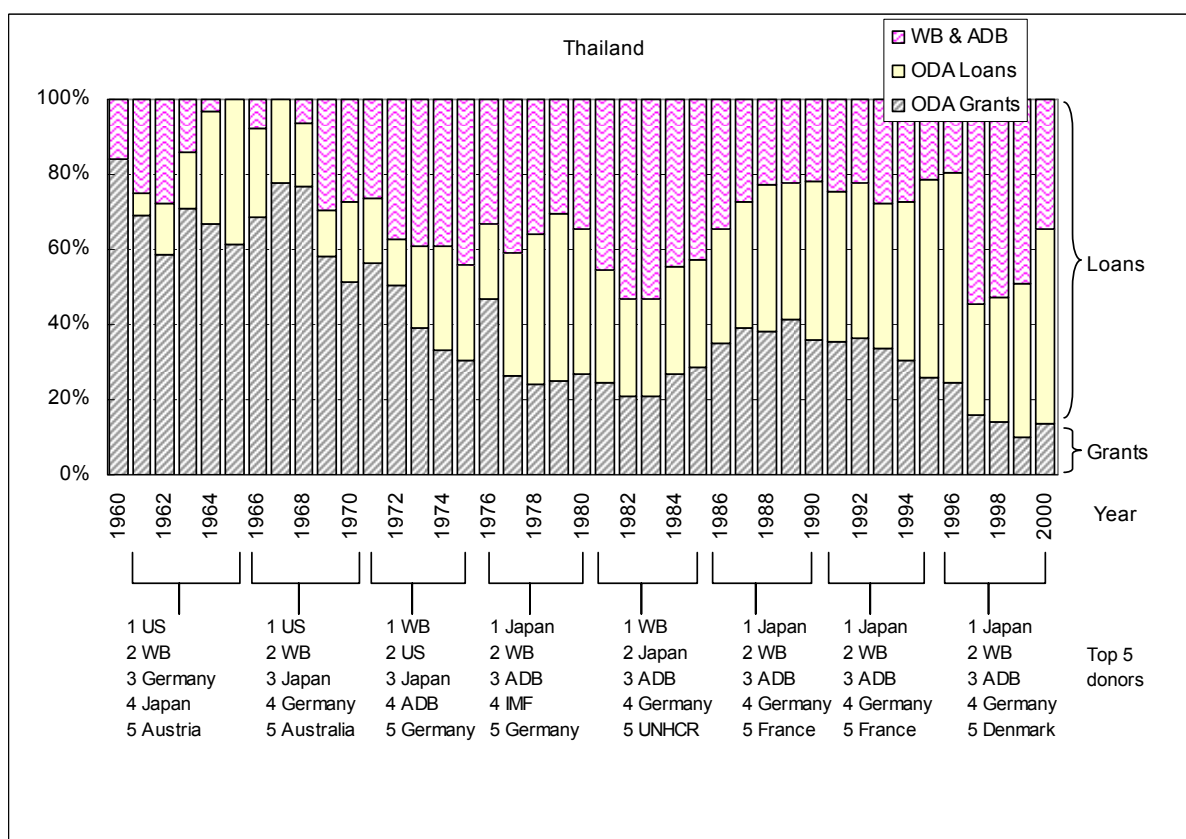
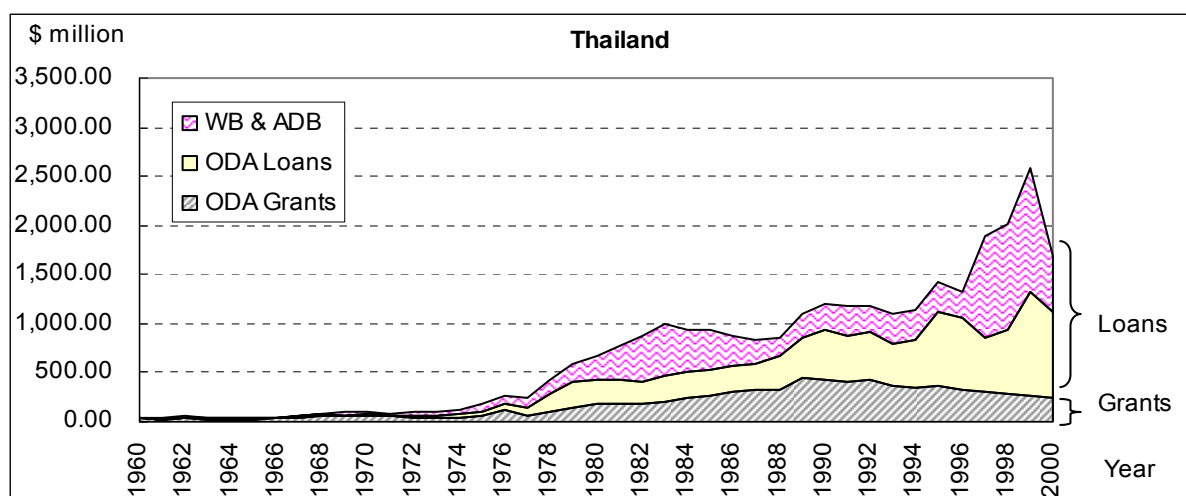

Note: The amount of aid (including WB and ADB) is calculated on a gross disbursement base.  
Source: OECD/DAC, *Geographical Distribution of Financial Flows to Aid Recipients 2000/2004*.

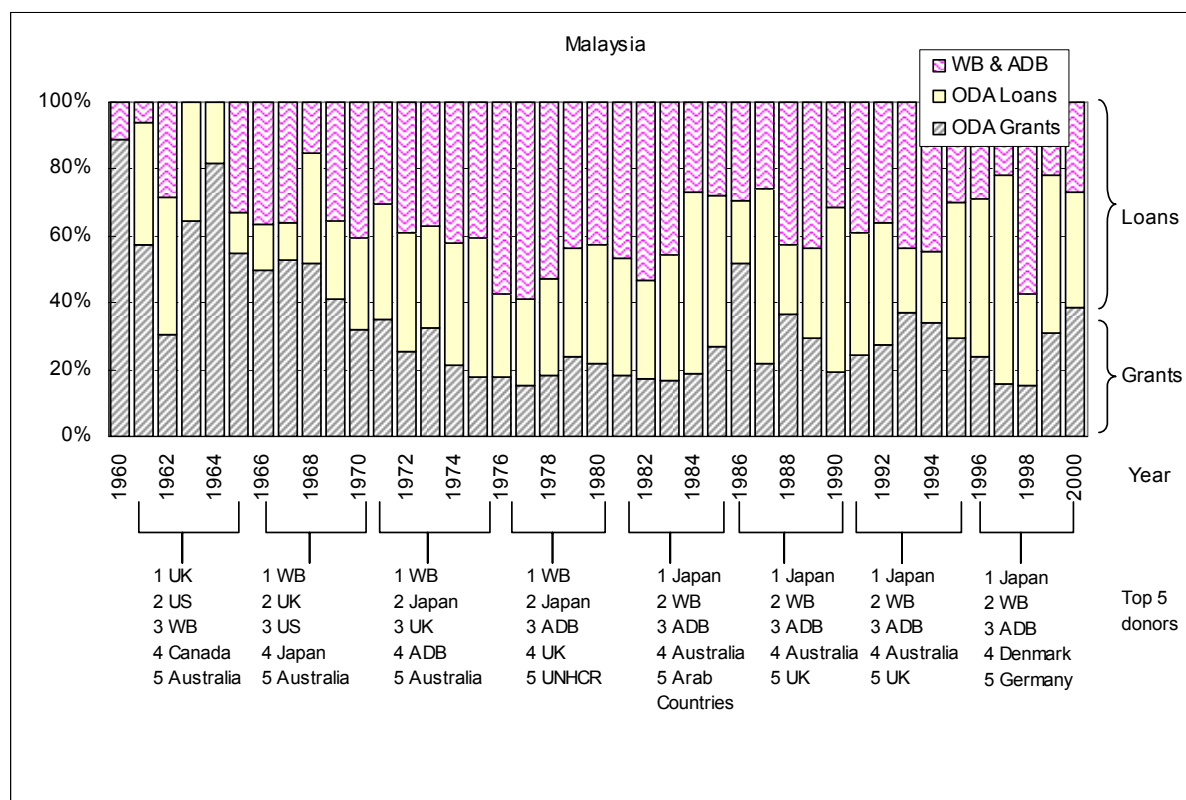
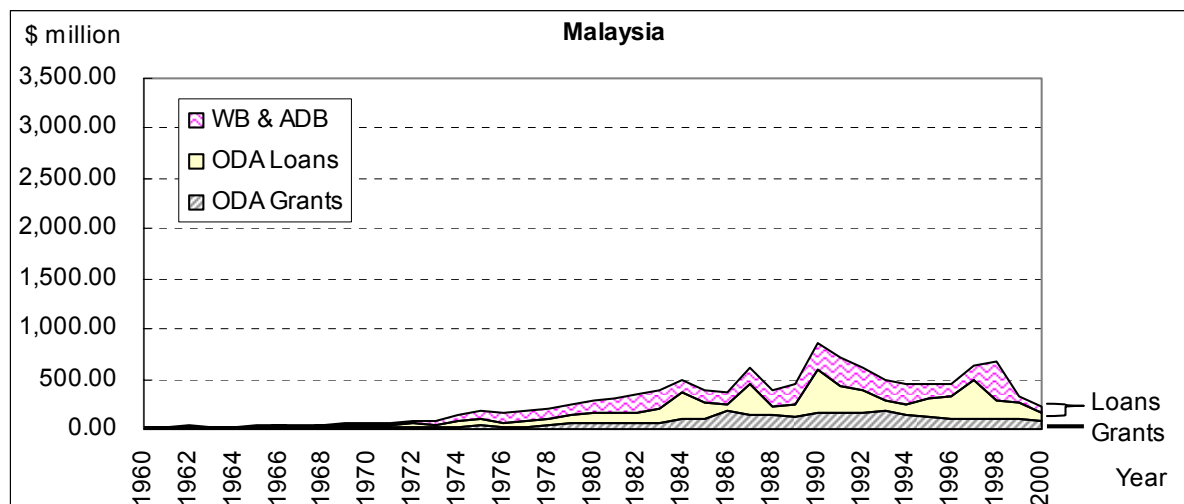

Note: The amount of aid (including WB and ADB) is calculated on a gross disbursement base.  
Source: OECD/DAC, *Geographical Distribution of Financial Flows to Aid Recipients 2000/2004*.

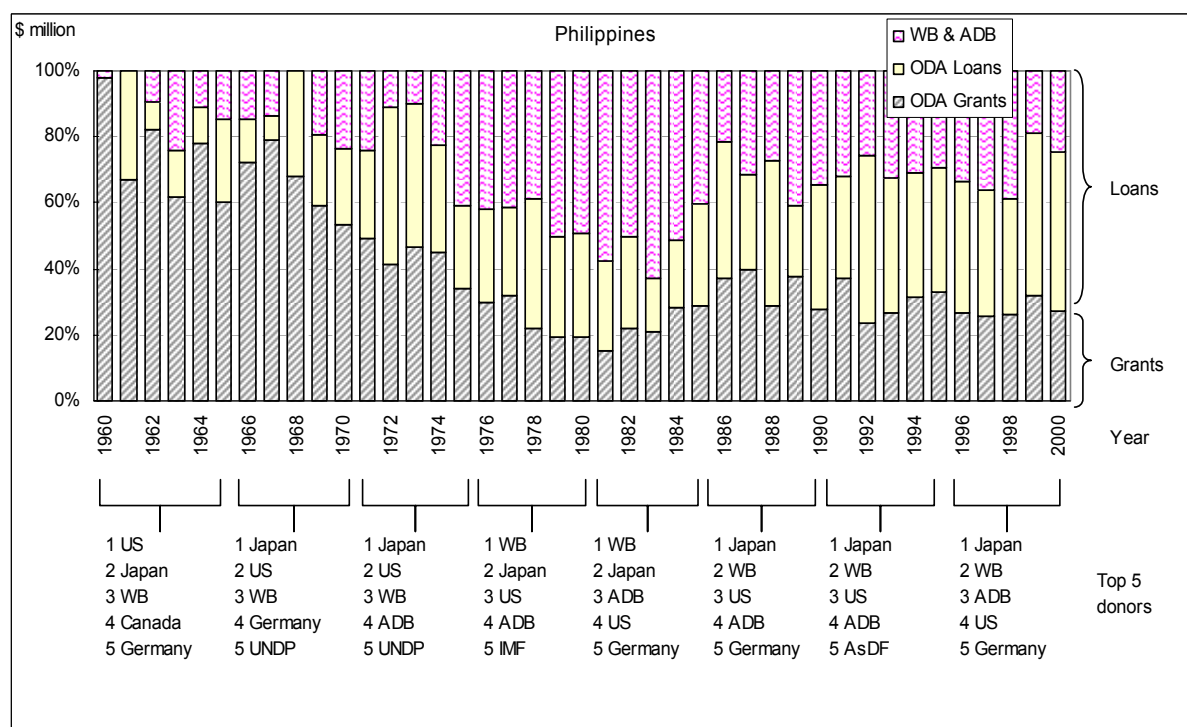
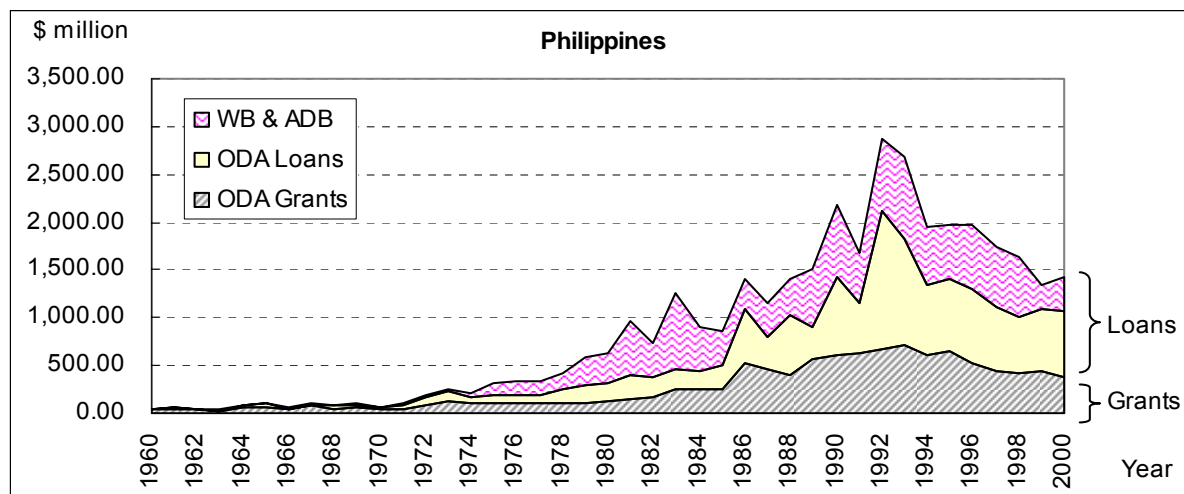

Note: The amount of aid (including WB and ADB) is calculated on a gross disbursement base.  
Source: OECD/DAC, *Geographical Distribution of Financial Flows to Aid Recipients 2000/2004*.

Slide 1

The slide features a light gray grid background. A central text box with a multi-colored border (green, blue, purple, pink) contains the title. Below the title, the text 'GRIPS Development Forum', 'Masumi Shimamura', and 'November 8, 2006' is centered. A decorative bar with a repeating pattern of colored squares is at the bottom.

**Managing the Development Process and Aid  
-- Key Factors Affecting the Effectiveness of  
Development Administration and Aid Management  
in East Asian Countries --**

GRIPS Development Forum  
Masumi Shimamura  
November 8, 2006

Slide 2

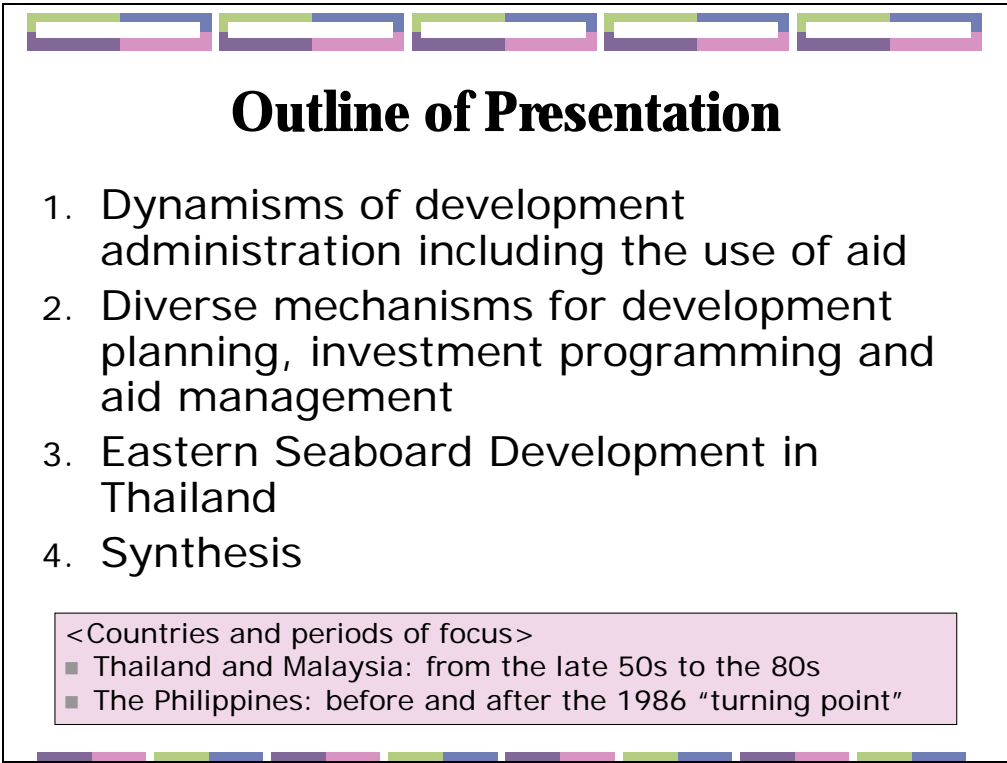
The slide has a light gray grid background. At the top, there is a decorative bar with a repeating pattern of colored squares. The title 'Outline of Presentation' is centered. Below it is a numbered list of four items. At the bottom, a pink box contains a legend for the focus countries and periods.

**Outline of Presentation**

1. Dynamisms of development administration including the use of aid
2. Diverse mechanisms for development planning, investment programming and aid management
3. Eastern Seaboard Development in Thailand
4. Synthesis

<Countries and periods of focus>

- Thailand and Malaysia: from the late 50s to the 80s
- The Philippines: before and after the 1986 "turning point"

Slide 3

## 1. Dynamisms of development administration including the use of aid

	Thailand	Malaysia	The Philippines
<u>Formulation of development administration</u>	◆Late 50s-early 60s: with donor advice (WB, US etc), basic foundations for coordination mechanisms established among central economic agencies	◆Late 50s-early 60s: with donor advice (WB, US, UK etc), basic foundations for planning and coordination mechanisms established and the PM's Department strengthened	◆70s: centralized development administrative body (NEDA) created ◆After 86: NEDA reorganized, and inter-agency committees began to facilitate coordination
<u>Enhancement of development administration</u>	◆80s: national-level committees and sub-committees established to facilitate coordination of priority policy agenda and public-private coordination strengthened	◆70s: new administrative machinery (esp. ICU) added to implement New Economic Policy ◆80s: coordination system between public and private sector strengthened	◆90s: inter-agency committee functions institutionalized, and ODA management strengthened, but legislative intervention marginalizing such executive efforts

Slide 4

## Thailand: Major characteristics of the development administration

**<Thailand>**  
esp. in 1980s

- ◆ "Bureaucratic polity"

Centralized system managed by elite technocrats who were delegated authority from political leaders

Slide 5

## Malaysia: Major characteristics of the development administration

**<Malaysia>**

- ◆ "Top-down" development administration

Centralized system led by political leaders and supported by elite technocrats to realize leaders' vision

Support to realize leader's vision

Centralized system

Leader

Technocrats (Central Economic Agencies)

Ministries, departments, other state organs and local governments

Slide 6

## The Philippines: Major characteristics of the development administration

**<The Philippines>**  
esp. after 1986

- ◆ "Dual track" development administration

Dual system administered by executive branch but challenged by legislative intervention

Legislature

Intervention

Executive branch

Leader

Technocrats (Central Economic Agencies)

Ministries, departments, other state organs and local governments

Slide 7



**Key factors affecting the formulation and enhancement of the development administration**

- ◆ Quality of leadership
  - long-term visions and political will
- ◆ Alliance between leadership and technocrats
  - role of technocrats to realize leaders' visions
- ◆ Fear of external and domestic crises
  - a sense of political, social and economic urgency
- ◆ Degree of political intervention to the "executive branch"
- ◆ Utilization of aid as integral part of development management



Slide 8



**Key factors affecting the formulation and enhancement of the development administration**

**<Basic assumption>**

- ◆ Synergetic effects of each "factor" affected the countries' overall development administration
- ◆ (Uncontrollable) external factors (both positive and negative) gave major impacts on the development administration
  - ◆ Effect of the 1985 Plaza Accord in Thailand
  - ◆ Aftermath of the 1969 ethnic riot in Malaysia
- ◆ Leadership mattered especially at the critical stages of development
  - ➔ Thailand and Malaysia were blessed with well balanced, visionary and dedicated leaders at times of turning points



Slide 9

<b>Thailand: Key factors affecting the formulation and enhancement of the development administration</b>	
Quality of leadership	<ul style="list-style-type: none"> <li>◆ PM Sarit (Late 50s-early 60s) -- showed development vision and exercised strong leadership</li> <li>◆ PM Prem (80s) -- played a leading role especially in priority policy agenda, and delegated authority to technocrats</li> </ul>
Alliance between leadership and technocrats	◆ Competent technocrats functioned as strong support arms to administer policy
Fear of external and domestic crises	◆ Thai gov't strived for structural transformation (late 70s-80s)
Degree of political intervention to the "executive branch"	◆ Technocrats were effectively insulated from political pressures
Utilization of aid as integral part of development management	◆ Thai gov't strategically and selectively utilized donor assistance for "graduation"

Slide 10

<b>Malaysia: Key factors affecting the formulation and enhancement of the development administration</b>	
Quality of leadership	<ul style="list-style-type: none"> <li>◆ PM Rahman (Late 50s-70s) -- exercised strong leadership to carry out effective rural development</li> <li>◆ PM Razak (70s) -- played a leading role in enhancing administrative machinery to implement New Economic Policy</li> <li>◆ PM Mahathir (80s-) -- exercised strong leadership in strengthening public private partnership</li> </ul>
Alliance between leadership and technocrats	◆ Technocrats made efforts to enhance administrative capacity and human resource development to realize PM's vision and policy objectives
Fear of domestic crises	◆ Malaysia gov't utilized development machinery as a tool to realize the country's overriding objective: promoting national unity through "poverty eradication" and "restructuring of society"
Utilization of aid as integral part of development management	◆ Malaysia gov't strategically and selectively utilized donor assistance for "graduation"



Slide 11

<b>The Philippines: Key factors affecting the formulation and enhancement of the development administration</b>	
Quality of leadership	<ul style="list-style-type: none"> <li>◆ President Marcos (prior to 86) -- created central development administration system to maintain his dictatorship</li> <li>◆ President Aquino (after 86) -- reorganized development administration system with the resumption of democracy</li> <li>◆ President Ramos (90s) -- strengthened and institutionalized development administration system</li> </ul>
Alliance between leadership and technocrats	<ul style="list-style-type: none"> <li>◆ Technocrats streamlined administrative structures and functions to efficiently carry out development policy</li> </ul>
Degree of political intervention to the "executive branch"	<ul style="list-style-type: none"> <li>◆ "Legislative intervention" over the "executive branch", especially during the budget process, undermining the role and efforts by the technocrats</li> </ul>
Utilization of aid as integral part of development management	<ul style="list-style-type: none"> <li>◆ The Philippine gov't has been utilizing foreign assistance actively -- strategic and selective use of aid???</li> </ul>

Slide 12

<b>2. Diverse mechanisms for development planning, investment programming and aid management</b>			
	Thailand	Malaysia	The Philippines
Development Plans	<ul style="list-style-type: none"> <li>◆ Indicative plan utilized as strategic core documents (dev't priorities clearly indicated)</li> <li>◆ Do not specify budget allocation</li> <li>→ securing room for flexibility</li> </ul>	<ul style="list-style-type: none"> <li>◆ Directive plan utilized as strategic core documents (dev't priorities clearly indicated)</li> <li>◆ Specify budget allocation</li> <li>→ adjusted at mid-term review</li> </ul>	<ul style="list-style-type: none"> <li>◆ Still insufficient as strategic core documents (in spite of ongoing efforts)</li> <li>◆ Do not specify budget allocation</li> <li>→ lacking alignment with budget implication</li> </ul>
Public Investment Plans	<ul style="list-style-type: none"> <li>◆ Public investment selected in the subsequent annual budget and debt approval process (except for the 70s - 3<sup>rd</sup> and 4<sup>th</sup> Development Plans)</li> </ul>	<ul style="list-style-type: none"> <li>◆ Public investment selected as part of development planning process</li> <li>→ Development Plans play the role of <i>de facto</i> PIP</li> </ul>	<ul style="list-style-type: none"> <li>◆ Public Investment Plans prepared in parallel with Development Plans, but their linkages remain weak</li> <li>→ still remain as "wish list" of projects</li> </ul>
Project approval	<ul style="list-style-type: none"> <li>◆ Project approval integrated into annual budget/debt approval process</li> </ul>	<ul style="list-style-type: none"> <li>◆ Project approval conducted as part of development planning process</li> </ul>	<ul style="list-style-type: none"> <li>◆ Project approval conducted after PIP process and before annual budget process</li> </ul>

Slide 13

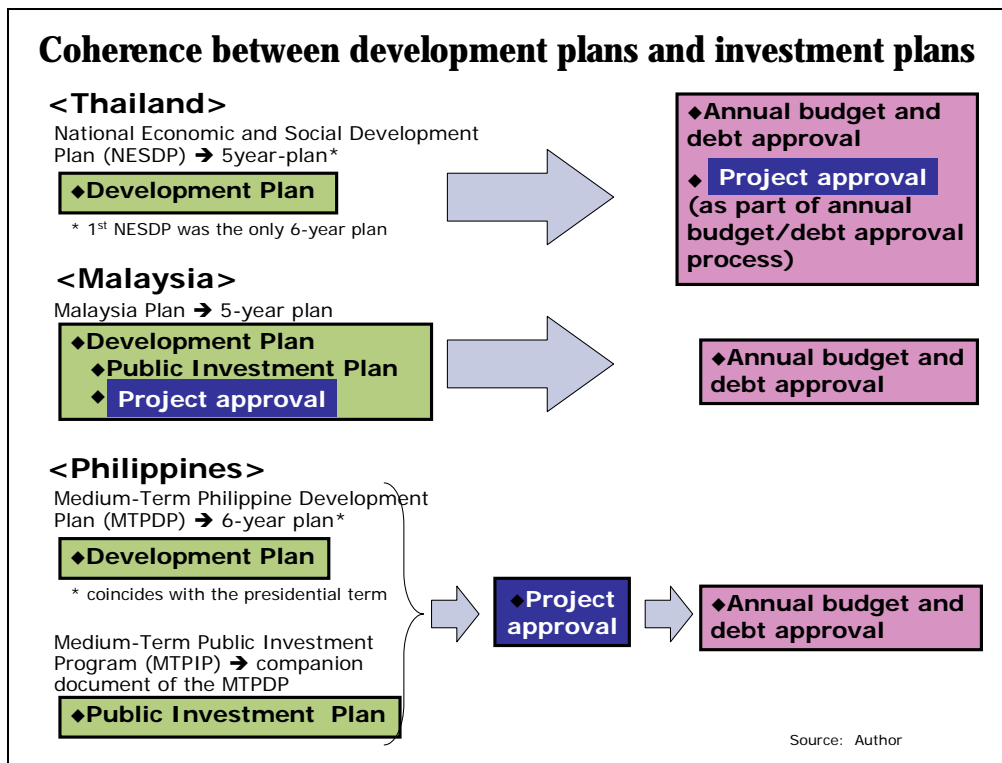

Slide 14

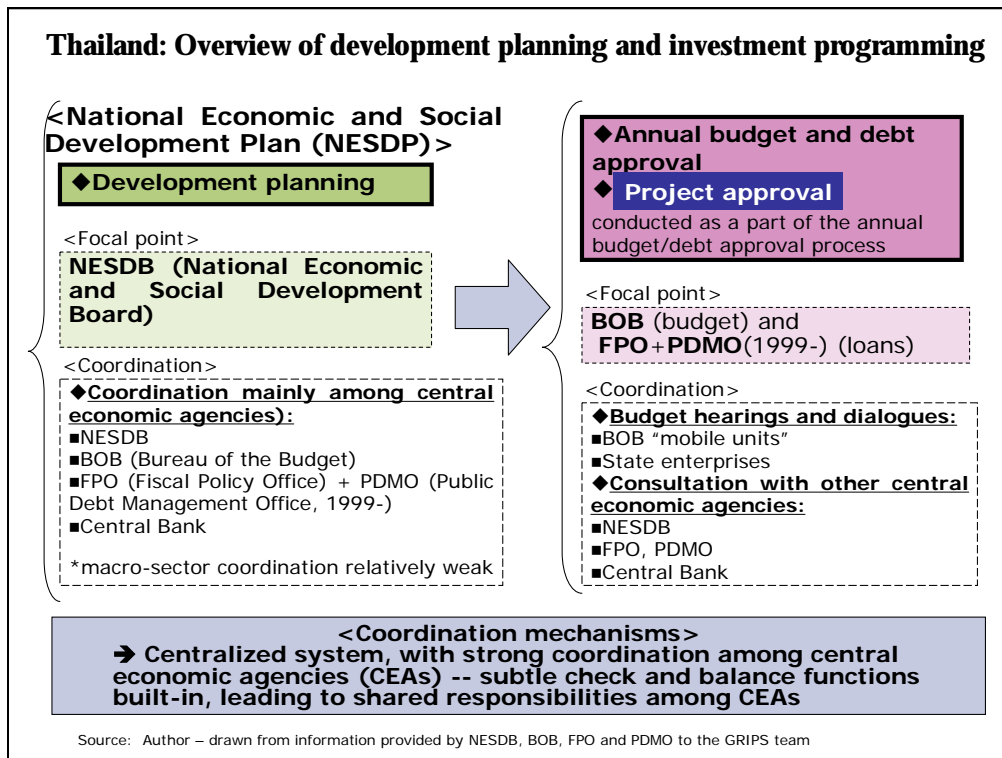

**<Coordination mechanisms>**

→ Centralized system, with strong coordination among central economic agencies (CEAs) -- subtle check and balance functions built-in, leading to shared responsibilities among CEAs

Slide 15

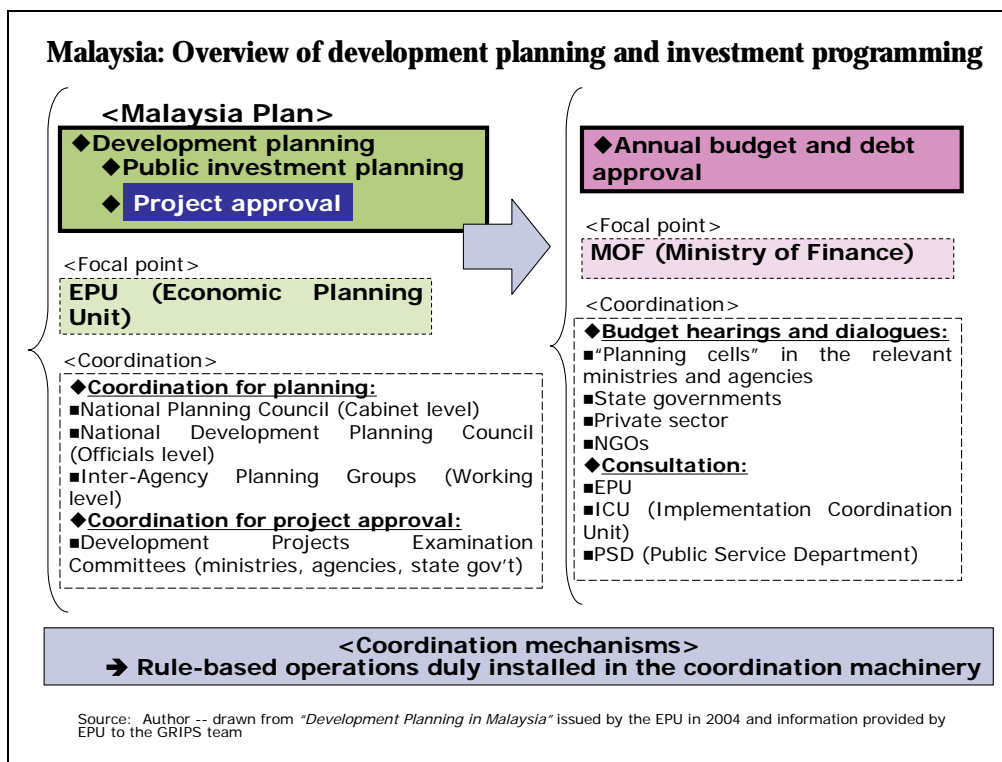

Slide 16

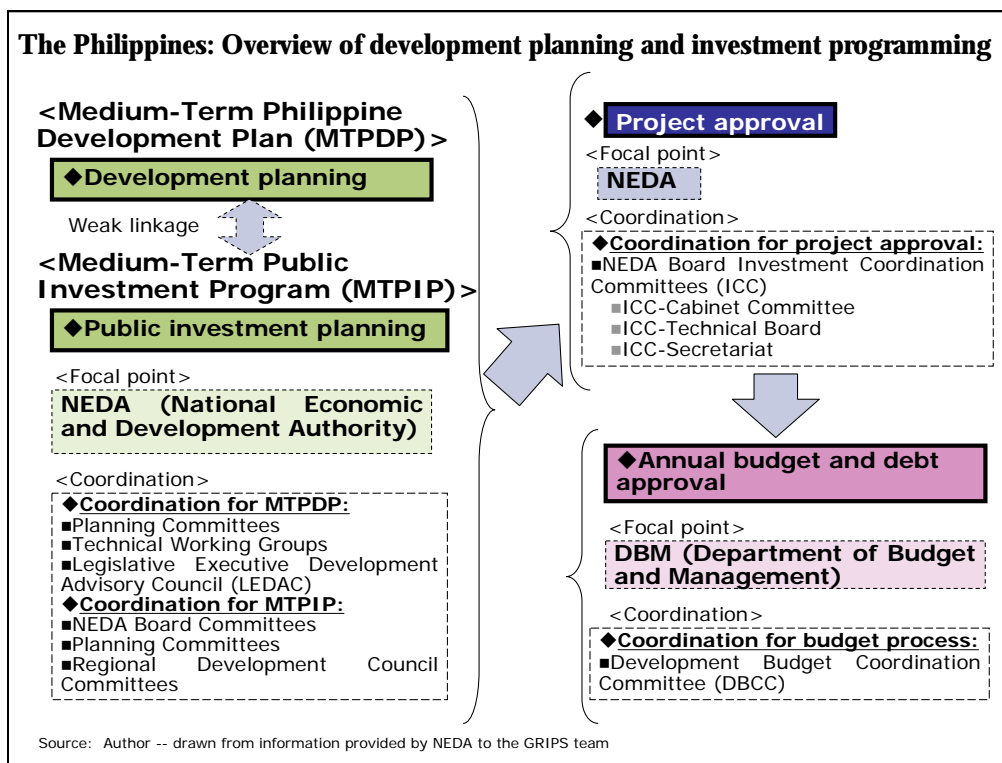

Slide 17

## Coherence between development plans and investment plans

**<Thailand>**

- ◆ NESDPs used to be quantitative, strategic guidance with resource allocations → now descriptive, qualitative analysis

**<Malaysia>**

- ◆ Malaysia Plans maintaining the roles as the quantitative and strategic guidance for development objectives and resource allocations

**<The Philippines>**

- ◆ Executive efforts on-going to strengthen the MTPDPs and the MTPIPs to become strategic guidance for development objectives and resource allocation
- ◆ ...but "legislative interventions" undermining these efforts

Slide 18

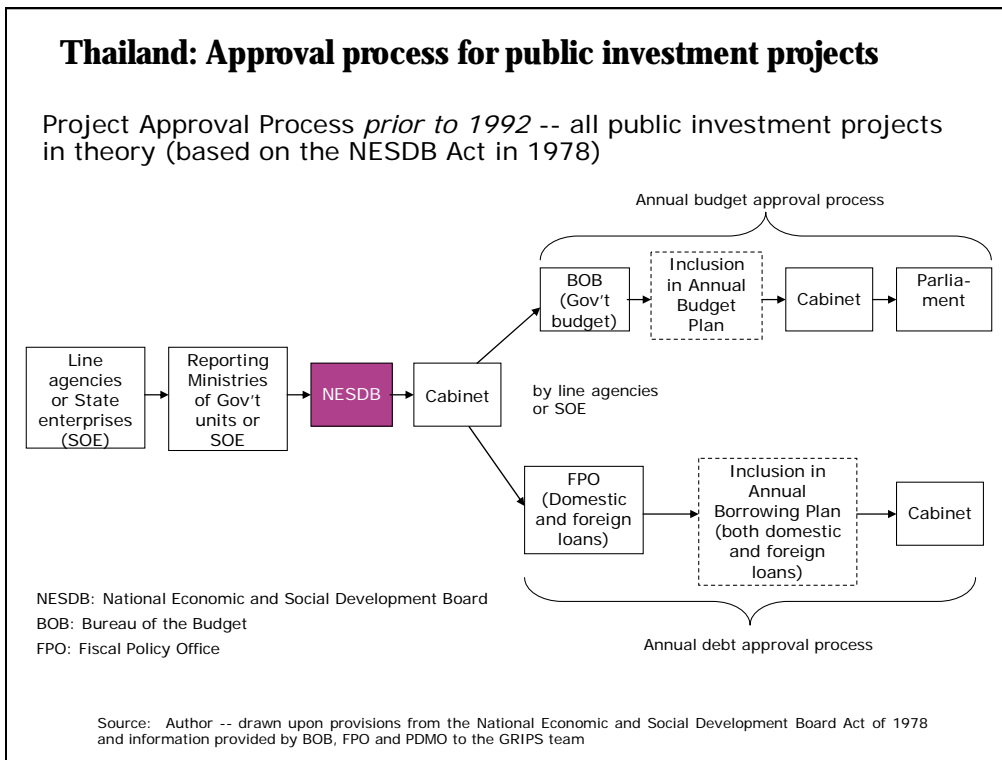

Slide 19

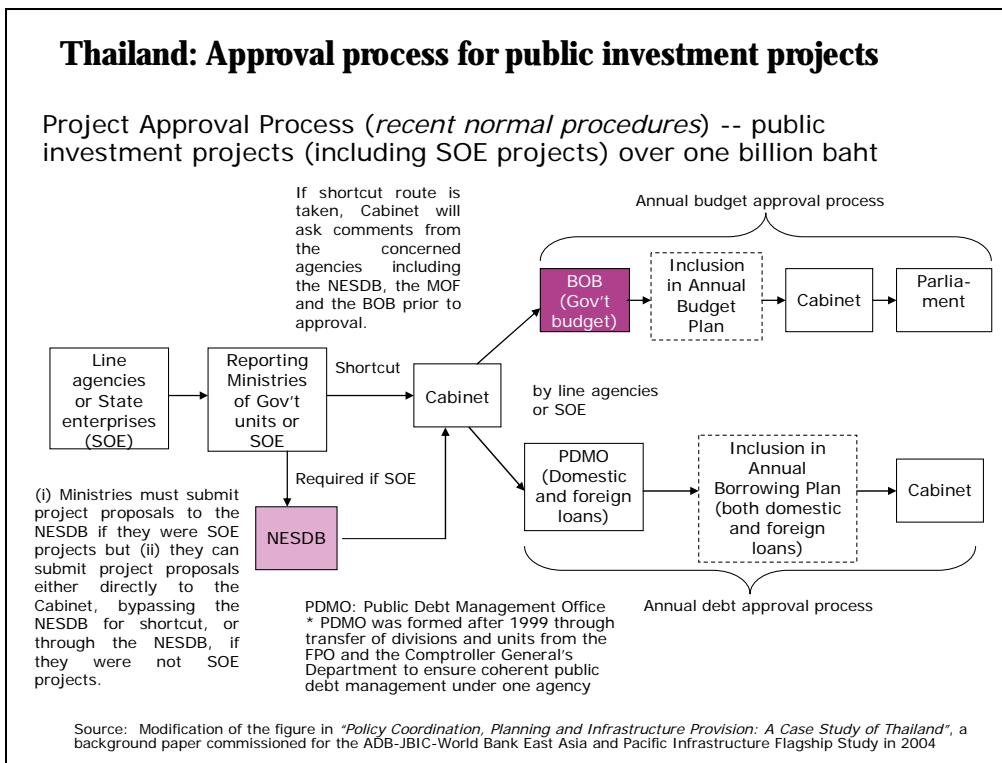

Slide 20

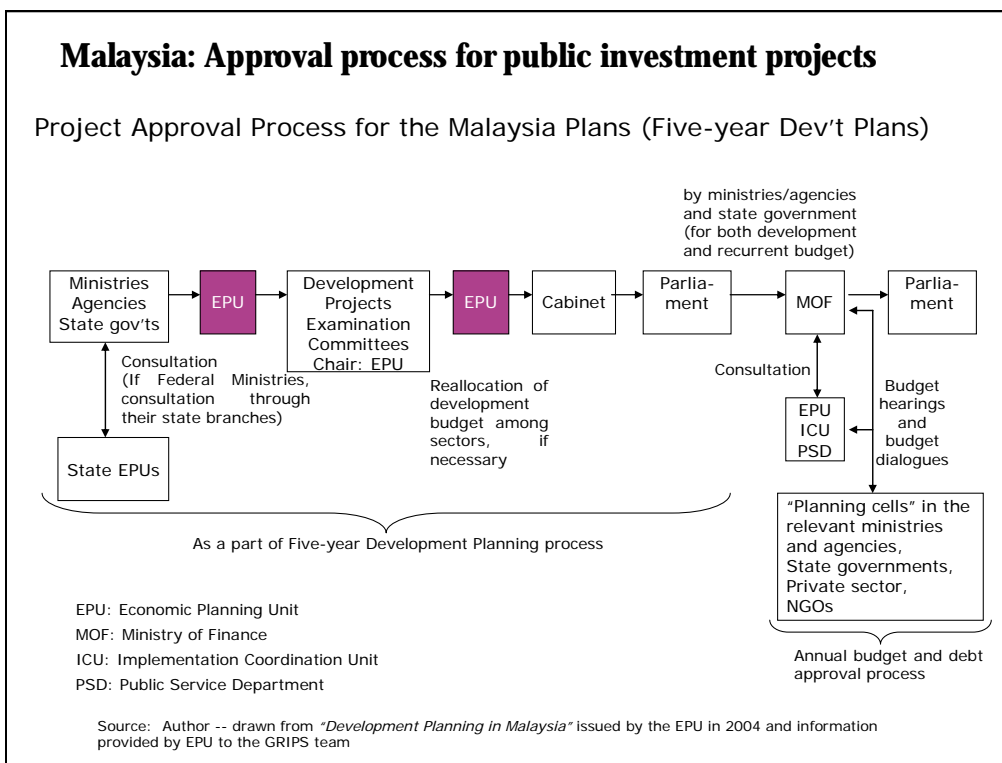

Slide 21

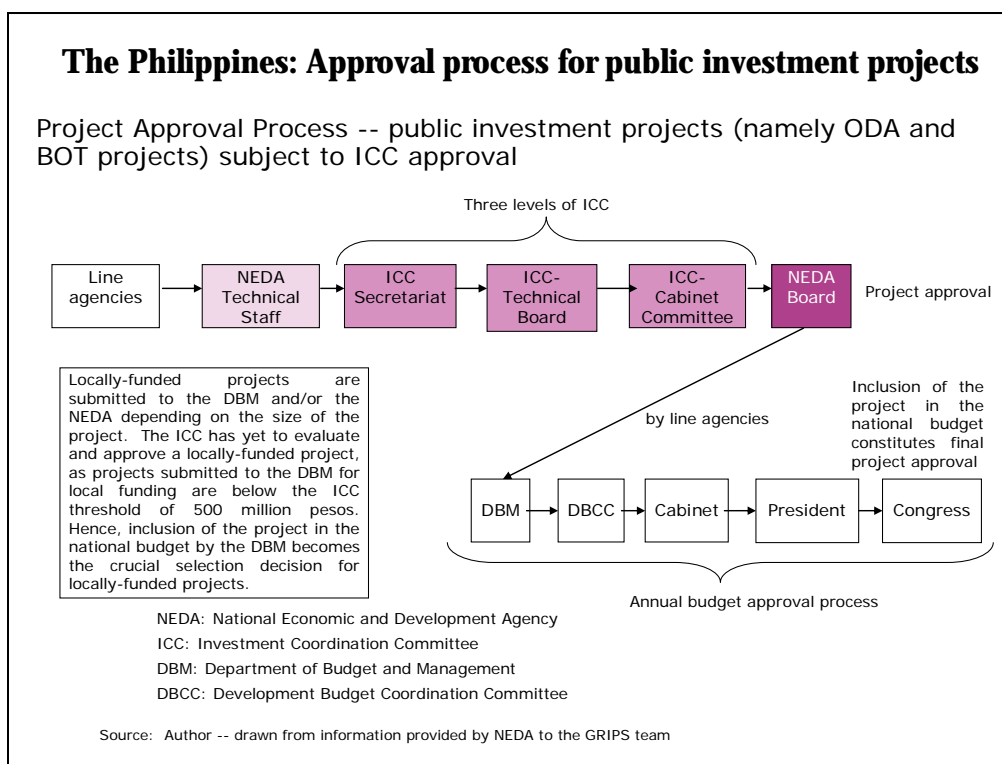

Slide 22

### Project preparation and investment decision process for locally funded projects and ODA projects

Thailand	Malaysia	The Philippines
<p>◆ "Integrated system"</p> <p>➔ Same procedures and criteria applied as part of annual budget/debt approval process</p>	<p>◆ "Integrated system"</p> <p>➔ Regardless of the sources of funds, any candidate projects must be scrutinized as part of the planning process of the Malaysia Plans</p>	<p>◆ "Dual system"</p> <p>➔ Procedures and criteria applied for locally-funded projects are less intensive and less well defined than those applied to ODA projects</p>

Slide 23



**Project preparation and investment decision process**  
**-- comparison among the three countries --**

**<Thailand and Malaysia>**

- ◆ "Integrated system"
- ◆ Strategically and selectively utilized aid
  - ➔ Both gov'ts strategically shifted donor composition and the form of aid in accordance with their development stages
  - ➔ Both gov'ts have been careful about maintaining bargaining power against donors

**<The Philippines>**

- ◆ "Dual system"
- ◆ Setting up dual and exceptional system for ODA would increase gov's administrative burden
  - ➔ create distortion and inefficiency to the economy as a whole



Slide 24



**3. Eastern Seaboard Development in Thailand**

- ◆ Mega infrastructure investments (development of special integrated economic zone) at the time of structural transformation (mainly in the 80s)
- ◆ Regarded as high priority development in the 5<sup>th</sup> and 6<sup>th</sup> NESDPs -- growth strategy with strong country ownership
- ◆ Lots of controversies among stakeholders on macroeconomic management and project sustainability
- ◆ Intensive and strategic use of aid as integral part of development management



Slide 25



**Key factors affecting the effectiveness of the development**

- ◆ Strong and effective leadership to ensure the public's interest
- ◆ Competency of technocrats
- ◆ Powerful central economic agencies (esp. NESDB)
- ◆ Special institutional settings
- ◆ Functioning coordination mechanisms
- ◆ External factors



Slide 26



**Key factors affecting the effectiveness of the development**

Quality of leadership	◆ PM Prem (80s) had sound vision, strong sense of commitment and strong leadership
Competency of technocrats	◆ Highly motivated, competent technocrats functioned as strong support arms to the PM
Powerful CEA (esp. NESDB)	◆ The NESDB given due authority and functioned as the Secretariat of the Eastern Seaboard Development Committee – <i>"influential liaison"</i>
Special institutional settings	◆ PM Prem created special coordination and decision making mechanisms exclusively for the development
Functioning coordination mechanisms	<ul style="list-style-type: none"> <li>◆ Highly centralized mechanism</li> <li>◆ De facto "fast track" process</li> <li>◆ Multilayered, check and balance function incorporated</li> <li>◆ Mechanism to pursue "strategic use of donor assistance" incorporated                             <ul style="list-style-type: none"> <li>→ pragmatic, independent judgment possible</li> </ul> </li> </ul>
External factors	◆ The significant impact of the Plaza Accord in 1985





Slide 27

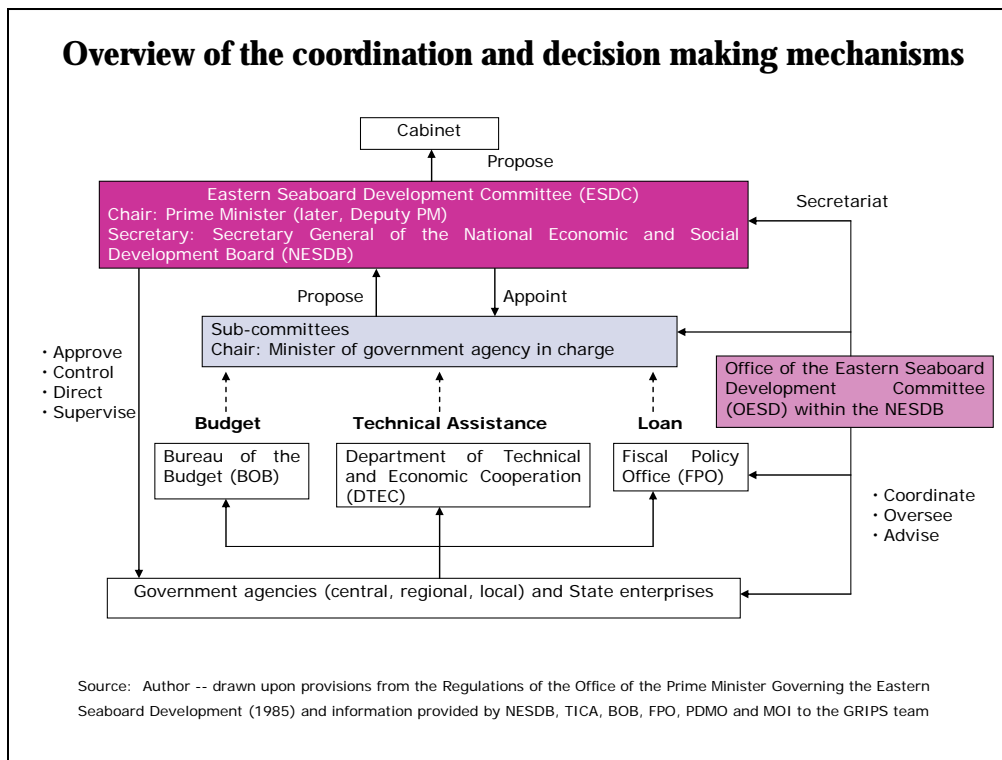

Slide 28

### Key factors affecting the effectiveness of the development

- ◆ Synergetic effects of each “factor” contributed to push forward the development
- ◆ Thai gov’t was capable of taking full advantage of the positive external factors (i.e. 1985 Plaza Accord) by utilizing the existing coordination mechanisms guided by the strong and effective leadership with the support of competent technocrats
- ◆ Thailand was blessed with excellent leaders at the time of structural transformation

Slide 29

## 4. Synthesis

- ◆Diverse institutional framework, coordination mechanism and approval procedures for development administration and aid management
- ◆Various quality and competency of key actors and relationship among them
- ◆Different configuration in terms of coherence between development plans and investment plans
- ◆“Integrated system” vs. “dual system” between locally-funded projects and ODA projects giving different implication in the use of aid and efficiency considerations

Slide 30

## Synthesis

- ➔Need to understand the country context carefully when aiming to enhance aid effectiveness
  - Quality of leadership
  - Alliance between leadership and technocrats
  - Role of central economic agencies and the coordination mechanisms
  - Degree of political intervention to the “executive branch”
  - Utilization of aid as integral part of development management

Slide 31



**Thank you very much!**

Please see our website for this study: "Managing the Development Process and Aid"

<English site>  
<http://www.grips.ac.jp/forum-e/research2006/aidmgt.htm>

<Japanese site>  
<http://www.grips.ac.jp/forum/aidmgt/index.htm>

We welcome your comments and feedback.

Slide 1



Slide 2



Slide 3

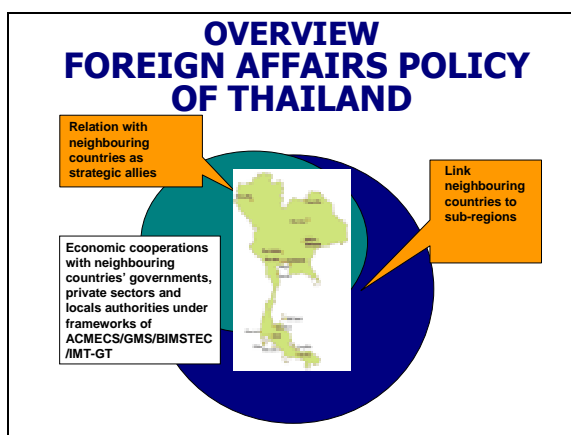

Slide 4



Slide 5



Slide 6

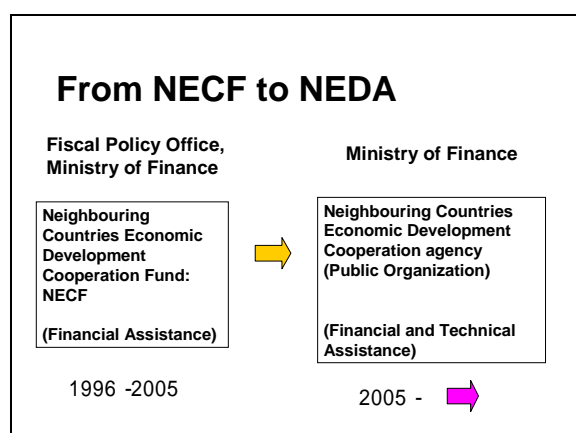

Slide 7

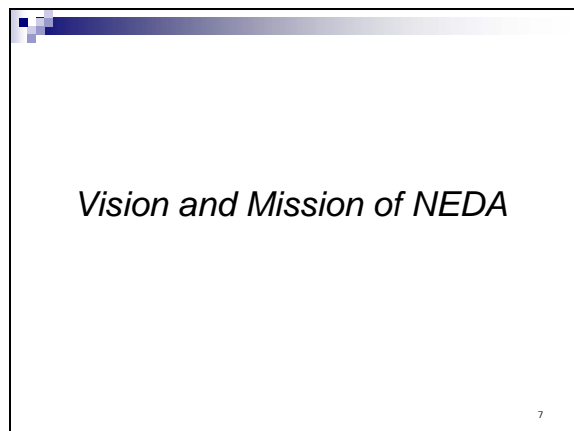

Slide 8



Slide 9



Slide 10



Slide 11

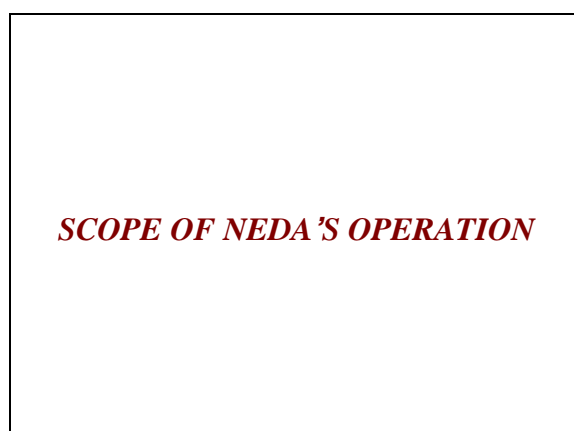

Slide 12

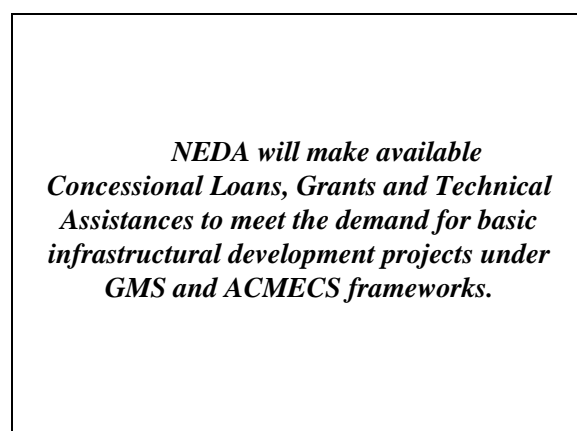

Slide 13

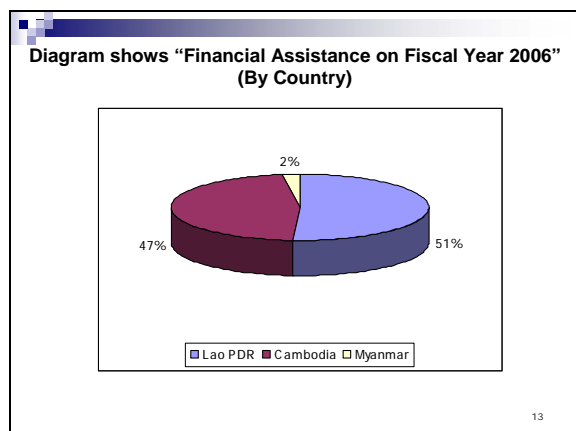

Slide 14

(Million Baht)

Country / Project	Amount of loan			Status
	Loans	Grants	Total	
<b>LAO PDR</b>				
1. Road Improvement Project (R3)	1,385.00	-	1,385.00	On going
2. Wattay International Airport Improvement Project	224	96	320	Completed
3. Railway Construction from Friendship Bridge to Ban Thanaleng	137.9	59.1	197	On going
4. The Construction of Drainage System and T2 Road Improvement Project in Vientiane Capital city	112	48	160	On going
5. Houi Kon – Pak Beng Road Development Project	588	252	840	On going
<b>Total</b>	<b>2,446.90</b>	<b>455.1</b>	<b>2,902</b>	

Slide 15

(Million Baht)

Country / Project	Amount of loan			Status
	Loans	Grants	Total	
<b>The Kingdom of Cambodia</b>				
6. Koh Kong – Sre Ambel Road Improvement Project (Route No. 48)	1,385.00	-	1,385.00	On going
7. Road Improvement Project (R67)	1,300.00	-	1,300.00	On going
<b>Total</b>	<b>2,685.00</b>	<b>-</b>	<b>2,685.00</b>	

Slide 16

(Million Baht)

Country / Project	Amount of loan			Status
	Loans	Grants	Total	
<b>Myanmar</b>				
8. The Construction of Road Route Tanintharyi – Myawaddy	-	122.61	122.61	Completed
<b>Total</b>	<b>-</b>	<b>122.61</b>	<b>122.61</b>	
<b>Grand Total</b>	<b>5,131.90</b>	<b>577.71</b>	<b>5,709.61</b>	

Slide 17

***ON GOING PROJECTS***

Slide 18

***LAO PDR***

Slide 19

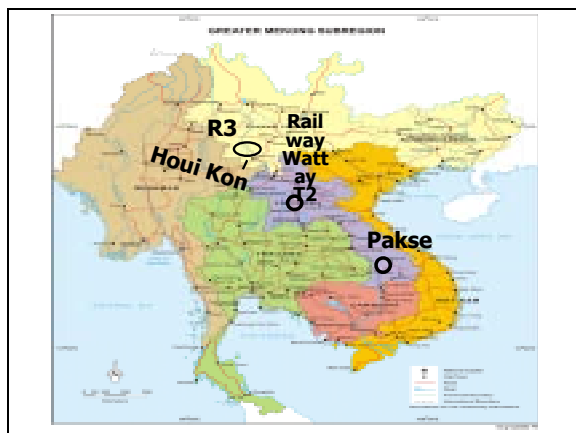

Slide 20

<b>LAO PDR Road Improvement Project (R3)</b>	
Amount	1,385 MB
Scope of work	Bokeo – Louang Namtha LAO PDR. (84.77 km.)
Cabinet Approved	5 Mar. 02
Signing date	9 Oct. 02
Conditions	
-interest rate	1.5% per year
-payment period (grace period)	30 years (10 years)
Disbursement (as of Sept. 06)	946.88 MB (68.44%)
Progress (as of Jul. 06)	64.01%

Slide 21

<b>LAO PDR Railway Construction from Friendship Bridge to Ban Thanaleng</b>	
Amount	197 MB
Scope of work	Nongkhai Province - Thanaleng LAO PDR. (3.5 km.)
Cabinet Approved	1 Jul. 03
Signing date	20 Mar. 04
Conditions	
-interest rate	1.5% per year
-payment period (grace period)	30 years (10 years)
Disbursement (as of Sept. 06)	2.54 MB (1.29%)
Progress	n.a.

Slide 22

<b>LAO PDR Houei Kon – Pak Beng Road Development Project</b>	
Amount	840 MB
Scope of work	Muang Ngeun - Pak Beng LAO PDR. (49.22km.)
Cabinet Approved	1 Jul. 03
Signing date	5 Feb. 04
Conditions	
-interest rate	1.5% per year
-payment period (grace period)	30 years (10 years)
Disbursement	-
Progress	-

Slide 23

<b>LAO PDR The Construction of Drainage System and T2 Road Improvement Project in Vientiane Capital city</b>	
Amount	160 MB
Scope of work	The Construction of Drainage System (2.7 km.) and T2 Road Improvement (6 km.) in Vientiane Capital city LAO PDR.
Cabinet Approved	30 Mar. 04
Signing date	5 Apr. 04
Conditions	
-interest rate	1.5% per year
-payment period (grace period)	30 years (10 years)
Disbursement	-
Progress	-

Slide 24

**CAMBODIA**

Slide 25

The Kingdom of Cambodia Koh Kong –Sre Ambel Road Improvement Project (Route No. 48)	
Amount	867.8 MB
Scope of work	Koh Kong –Sre Ambel Cambodia (151.5 km.)
Cabinet Approved	1 Jul. 03
Signing date	9 Jul. 03
Conditions	
-interest rate	1.5% per year
-payment period (grace period)	30 years (10 years)
Disbursement (as of Sept. 06)	515.59 MB (62.04%)
Progress (as of Aug. 06)	61.42%

Slide 26

The Kingdom of Cambodia Road Improvement (R 67) Anlongweng - Siamreap	
Amount	1,300 MB
Scope of work	Anlongweng - Siamreap (131 km.)
Cabinet Approved	1 Jul. 03
Signing date	10 Aug. 06
Conditions	
-interest rate	1.5% per year
-payment period (grace period)	30 years (10 years)
Disbursement	-
Progress	-

Slide 27



Slide 28

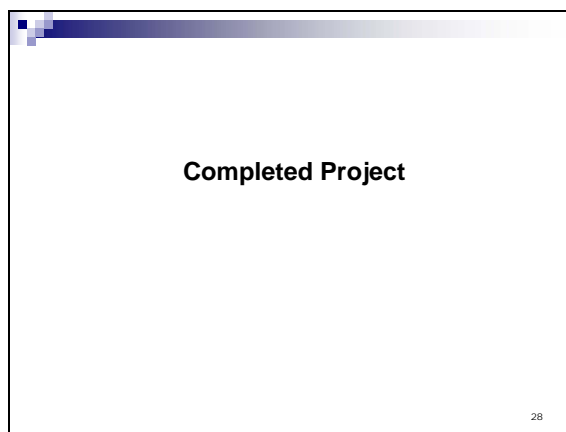

Slide 29

LAO PDR Wattay International Airport Improvement Project	
Amount	320 MB
Scope of work	Improvement of Wattay International Airport
Cabinet Approved	30 Mar. 04
Signing date	5 Apr. 04
Conditions	
-interest rate	1.5% per year
-payment period (grace period)	30 years (10 years)
Disbursement	319.99 MB (100%)
Progress	100%

Slide 30





Slide 31



Slide 32



Slide 33

**Myanmar  
The Construction of Road  
Tanintharyi – Myawaddy**

Amount	122.6 MB
Scope of work	Construction of Road Tanintharyi – Myawaddy
Cabinet Approved	20 Jan. 04
Signing date	-
Conditions	Grant
Disbursement	122.39 MB (99.82%)
<b>Progress</b>	<b>100%</b>

Slide 34



Slide 35

*Thank you*

## **Managing the Development Process and Aid**

Japan Bank for International Cooperation  
Takeo MATSUZAWA  
Director General, Dev. Assistant Dept.

### **Private Sector Perception**

How to assure the **“Predictability”** of the Development Policy

Thailand: Flexible to Private Sector Needs

Malaysia: Firm Continuity

Philippines: Inconsistent by change of the Government

**Prioritization** on the sector supported by the External Aid

Thailand: Road Network

Malaysia: Power Generation in the peninsular

Philippines: Not in particular

**Feedback Mechanism** of previous Mid-term (5years) Development Plan

Thailand: Policy Dialogue Mission (Dr.Ookita)

Slide 1

**Seminar on FDI promotion in African countries**  
**“ Strategic Action Initiatives for Economic Development : Strategies for Investment Promotion in Developing Nations**

Slide 2

**Venue: GRIPS Roppongi Camp**  
**November 9th 2006**

**Dato' J. Jegathesan**  
**Senior Investment Adviser :**  
Consultant to JICA and the Government of Zambia and the former Deputy Director General of the Malaysian Industrial Development Authority (MIDA)  
CEO - J J International Consultants

Slide 3

**REALITY CHECK**

- How is Africa (your country) perceived by others in respect of Investment Potential?
- What is the world global scenario of FDI flows on which Africa must depend upon?
- What are the lessons (in summary) that African Nations can learn from the Asian Experience?

Slide 4

Can South Nations (Africa) learn lessons from Asia?  
Can South Nations (Africa) learn lessons from Asia?

Slide 5

**ONE Lesson: LEADERSHIP is the KEY.**

- As CEOs of Companies forge Corporate Visions, Leaders of Nations must forge National Visions.
- Leader must be sensitive enough to feel the pulse and heartthrob of the nation and forge Visions that capture the imagination of all sectors.
- Leader must empower the people with the Vision so all feel that this is part of their Vision and all want to be part of the MISSION to realize VISION.

Slide 6

**MORE LESSONS...**

**COMPARATIVE ADVANTAGE NOT THE KEY!**  
Comparative Advantage of Raw Materials (Malaysia, Indonesia, Thailand) OR Location (Singapore, Hong Kong etc) are not enough.

**Key is Competitive Advantage ...e.g. Rubber**  
1970s Malaysia – world largest producer / exporter yet world's largest exporter of

- Rubber shoes – Viking Askim in Scandinavia
- Rubber swimming caps -- Skellrup in New Zealand

Slide 7

Yet within 1000 miles of NZ and Scandinavia – not a single rubber tree.

1970 – 1980 Malaysia focused not on RBI but labour and competitive advantage

After 1980 – Malaysia had both comparative and competitive advantage :- Viking Askim & Skellrup moved to Malaysia

All developing nations- to succeed- must focus on competitive advantage 

Slide 8

In simple terms:-

**Comparative Advantage** is conferred by God (i.e. Natural Resources / Location etc)

**Competitive Advantage** Must be manifested by man to make full use of **Comparative Advantage**.

Slide 9

For **Competitive Advantage**  
To manifest –

need for maximum cooperation, efficiency and incorruptibility among certain forces that initially make up a

**TRIANGLE OF HOPE**

Slide 10

■ In all Nations – the people, the citizen, the poor – look hopefully to a

**TRIANGLE of HOPE**

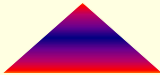

– to deliver jobs, opportunities, a decent life (wealth is a bonus).

Slide 11

**What is this Triangle of Hope?**

- its world symbol should be

**Hope**

Political Will & Integrity

Private Sector Dynamism & Integrity

**Hope**

Civil Service Efficiency & Integrity

Slide 12

All Hope for **POLITICAL WILL & INTEGRITY:** 

1) **Government leaders / Cabinet / Politicians/ Parliamentarians:** – who are selflessly dedicated to National development, are incorruptible. Have a vision for the future of their nation and see themselves as “gifted by God” to serve the Nation and its people selflessly.

**Political Will** is the key word.

Slide 13

**CIVIL SERVICE EFFICIENCY & INTEGRITY:**

2) **Civil servants** – who understand that they are “servants” of the people and not “Civil Masters”. They should be dedicated, incorruptible and totally apolitical, serving the Government in power and the people without fear or favour. **Civil service efficiency** is the key word.

Slide 14

**PRIVATE SECTOR DYNAMISM & INTEGRITY:**

3) **Corporate / Private Sector** – who are dynamic, are aware of the problems of the nations, do not just wait for handouts, who realize that only if the common people are happy and prosperous that they too can succeed. Are also incorruptible and are prepared to work with the Government in power to achieve National Prosperity.

**Private Sector Dynamism is the key word**

Slide 15

**Thus,**

Private Sector Dynamism & Integrity

Political Will & Integrity

**Hope**

Civil Service Efficiency Integrity

**Good news is: This may be OK initially.**  
**Bad News is: This will not be enough for Long Term Prosperity & Economic Stability!**  
**For this we need:**

Slide 16

**INVESTMENT PROMOTION**

**THE QUADRANT STRATEGY**

Export Orientation      Specific Promotion

Country Orientated      Image Building

**PROJECTS PROMOTION**  
Industries

**ENVIRONMENT IMPLEMENTATION**

General Environment      General Aspect

Specific Sectors      Specific

Slide 17

**Another MAJOR Lesson.**  
**Impact of GLOBALISATION.**

You either become a **CENTRE OF EXCELLENCE** for Manufacturing & Business...a super efficient “CBE”... “**CENTRE for BUSINESS EXCELLENCE**”. Than even if small you can excel. (e.g. Switzerland, Belgium, Luxembourg, Hong Kong & Singapore.)

OR

You provide a Big Market by yourself OR by Regional Economic Groupings & a relatively efficient Business/Investment Environment e.g. Japan, S.Korea, China, Malaysia, Thailand, Indonesia and now ASEAN etc.

Slide 18

**A Challenge!**  
**Can African Nations aspire to become CENTERS FOR BUSINESS EXCELLENCE?**

- Many years ago (1970), Malaysia was in the same position in terms of Economic Backwardness. Malaysia took the Challenge to become such a **CENTER FOR BUSINESS EXCELLENCE.**

**I PRESENT HERE NOW A GLIMPSE OF THE MALAYSIAN STORY.**

Slide 19

## The Malaysian Experience

...in Summary:

- Independence in 1957 from British Colonial Rule.
- Multi racial/ Religious Nation.
- Malays ( Muslims 50%), Chinese ( Christians, Buddhists etc 40% ) Indians & others (Hindus, Buddhists etc 10%)
- By 1965 Worlds largest exporter of Rubber, Hardwood Timber, Palm Oil, Tin, Pepper.
- ( Rubber from Brazil. Oil Palm from Africa)
- 1969...May 13<sup>th</sup>...RACE RIOTS devastated the nation.

Slide 20

## WHY DID IT HAPPEN?

- Rampant Unemployment
- Identification of Race with Economic Function.
- Imbalance in Wealth Distribution.
- FOREIGNERS : owned 60% of Corporate wealth.
- Malaysian CHINESE: 40% Pop....35%
- Mal. INDIANS & OTHERS: 10%....3%
- MALAYS: 50%...2% OF Corporate wealth.

**THE Government LAUNCHED A 20 YEARS OVERALL PERSPECTIVE PLAN (OPP) (1970 TO 1990) & NEW ECONOMIC POLICY (NEP)**

Slide 21

### Key Objectives of OPP & NEP

- \*Create Jobs & Wealth
- \* Redistribute Income and opportunities within context of a rapidly Expanding Economy.

#### RESULTS?

- When we started our Big Push in 1970 Malaysia was a Raw Material Producer & did not have even ONE export Oriented Manufacturing Company
- But 10 years later...in 1980 Malaysia had become:
- The Worlds Largest Producer of Electronic Semiconductors ( employing more than 150,000 people) &
- The 3<sup>rd</sup> Largest country in the world exporting Room Air conditioners.

Slide 22

## How was this possible?

- ▶ Certain elemental laws of nature guide natural forces on this earth and once Man recognizes these laws, he can tap these forces for benefit...
- ▶ Likewise Malaysia recognized the that certain elemental laws equally guide forces of Economics.
- ▶ We Recognized these laws and used them for our advantage.

Slide 23

## Elemental Law of Investment Flows :-

•Centrifugal (Push) Factor

•Centripetal (Pull) Factor

### PUSH FACTOR

At times in world economic history there are certain forces 'pushing companies' in capital and technology exporting nations to invest abroad - i.e become F.D.I.

<p><b>Negative Forces</b></p> <ul style="list-style-type: none"> <li>•Increasing Costs of producing locally</li> <li>•Increasing costs of electricity, water etc.</li> <li>•Increasing costs of environmental protection</li> <li>•Labour shortage and cost</li> </ul>	<p><b>Positive Forces</b></p> <ul style="list-style-type: none"> <li>•Expansion to new markets</li> <li>•Company's drive to diversify</li> <li>•Company wants to be close to raw material source</li> <li>•Company wants to be closer to the overseas market or supplier</li> <li>•Drive to take advantage of Regional markets e.g. ASEAN</li> <li>•Company divides the world into strategic geographic areas</li> </ul>
--	--

Slide 24

## PULL FACTORS

The PULL Factors can be put into a **Strategic Action Initiative Formula**

Or

### S.A.I. FORMULA

FAR EASTERN EXPERIENCE

FORMULA FOR SUCCESS IN Economic Development

$E + C_4 + O = P$  → Not Problems

P

Profits for Enterprises

Prosperity for the Nation



Slide 25

**E**  $E + C_4 + O = P$   
Environment – THE 10 COMMANDMENTS  
Or Check Points that every investor MUST observe

1. Political Stability
2. Economic Strength / Fundamentals
3. Attitude of Welcome – from highest Minister to most junior civil servant and public
4. Government policies
  - a. Equity
  - b. Employment of Expatriates
  - c. Exchange control
  - d. Rule of Law (Ownership of Assets etc)

Slide 26

**E**  $E + C_4 + O = P$   
Environment – THE 10 COMMANDMENTS  
Or Check Points that every investor MUST observe

5. Infrastructure- land, Electricity, water etc.; Availability, Costs, Quality, etc.,
6. Labour (Trainability, Education, Work Ethics, Harmony...all these spell one word PRODUCTIVITY)
7. Banking & Finance
8. Government Bureaucracy – friend & ally or hostile obstacles
9. Local Business Environment
10. Quality of Life

Slide 27

In the 10 Checkpoints –  
No Mention of Incentives

**Incentives are CRITICAL**

But are the **Icing on the Cake!!**

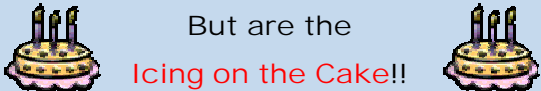

The 10 Checkpoints constitute the Solid Fruit Cake i.e. the company must make profits.

In a bakery– which would most people choose?  
The Cake without icing or the Cake with the icing...  
**Investors do the same.**

Slide 28

$E + C_4 + O = P$

**C<sub>4</sub>**

- Cost of Doing Business
- Convenience provided at all stages
- Capability of the Infrastructure and Government Machinery
- Concessions (carrots) – Incentives, etc.,

Slide 29

$E + C_4 + O = P$

**O**

**Opportunities** – What opportunities does the country offer? Mining, Trading, Manufacturing, agriculture, etc., Is this available in Government or private sector publications? In short how will the investor know the opportunities for import substitution or Export orientation that the country offers.

Slide 30

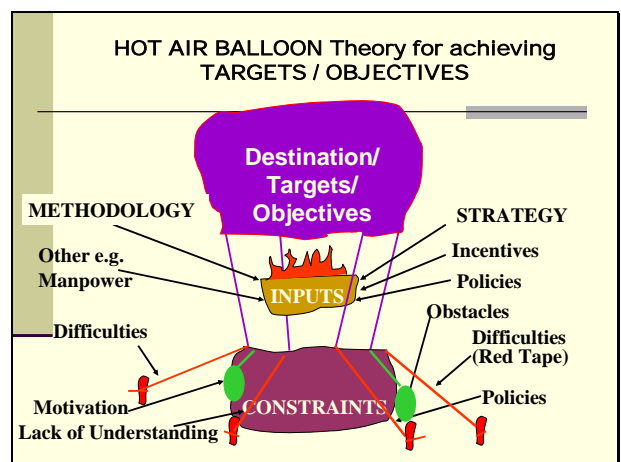

Slide 31

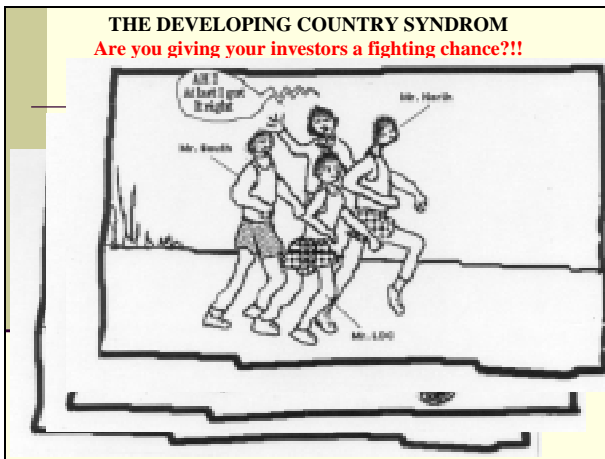

Slide 32

**AGENDA for ACTION**

- ▶ **Need for a strategic Plan of Action...based on a VISION of what you want your country to be.**
- ▶ **This Vision must come from Top leaders and the Civil Service and Private Sector (Business & Workers) must join forces to realize Vision.**
- ▶ **Not emotional nationalism but Strategic Action Initiatives designed for Short, Medium and Long Term Results.**

Slide 33

**Emotional Nationalisms???**

- 1) Why must foreigners come and make profits in my country?
- 2) Local people must own everything , Banks, Insurance etc. let foreigners take minority share?
- The lesson Malaysia learnt was this:
- Do we want to own 100% of 100
- OR
- 40% of 1000.
- The key is a dynamically expanding economy...
- So that Wealth & not Poverty is distributed.

Slide 34

**RECOGNIZE THAT CURRENTLY 3 Great Waves drive Economies of Nations**

**1<sup>st</sup> Wave.** – Agriculture – slow moving- long term - **continue this initiative!**

**KEY: Cost efficiency & Productivity.**

**2<sup>nd</sup> Wave** – Industrial Development: must establish competitive advantage.  
**Who are your competitors?**

**3<sup>rd</sup> Wave** – Service / Knowledge based drive....! Knowledge workers are driving World Economy.

Slide 35

**TECHNOLOGIES FOR SOUTH NATIONS FOR ECONOMIC SUCCESS**

**Everybody is looking at ICT...BUT...**

In looking at **ICT** (Information & Communication Technology) – African Nations should have a multi pronged strategy!

- **MCT** – Manufacturing & Creative Technology
- **ACT** – Agriculture & Commodity Technology
- **BCT** – Building & Construction Technology
- **FCT** – Finance & Currency Technology

ALL these Technologies will lead to **EMPOWERMENT** of South Nations!  
**This is what Asia did!**

Slide 36

**VII) The Role of IPA.**

**ONE KEY ELEMENT IN THE STRATEGIC ACTION INITIATIVE (S.A.I.) FORMULA IS....**

**The role of the National Investment Promotion Agencies (IPA)**



Slide 37

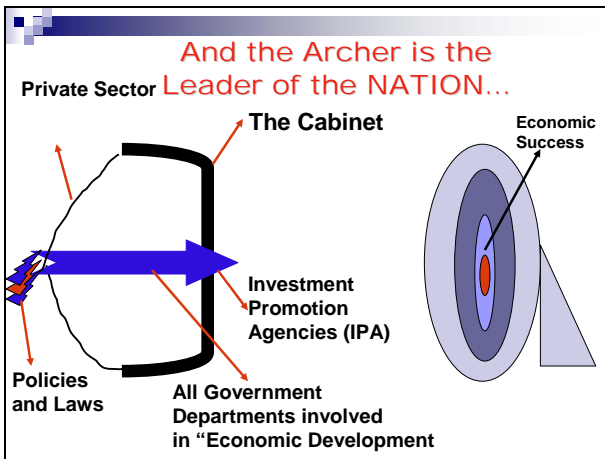

Slide 38

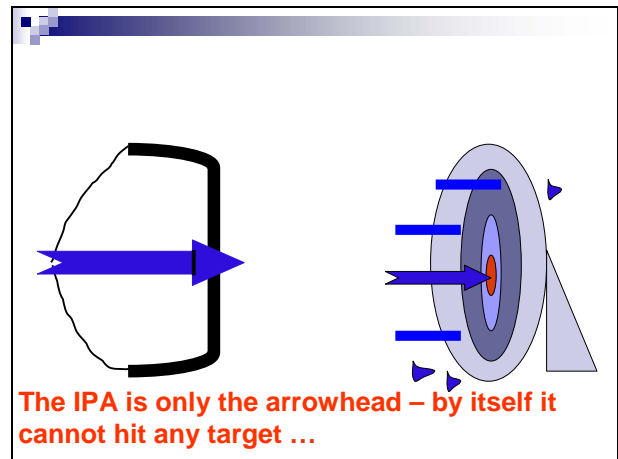

Slide 39

**What can AFRICAN Nations learn from the Asian experience?**

- Let us examine a possible Action Agenda through the spectrum of the:

**TRIANGLE OF HOPE**  
&  
**THE QUADRANT STRATEGY!**

Slide 40

**IN RESPECT OF THE TRIANGLE OF HOPE**

1) **POLITICAL WILL:** Briefing Sessions can be held for all Members of Parliament/Ministers (including Opposition members), on subjects relating to:

**STRATEGIC ACTION INITIATIVES FOR ECONOMIC DEVELOPMENT AND THE ASIAN EXPERIENCE (one example: Malaysia)**

(Malaysia, a multi racial Islamic nation, which became independent in 1957...about the same time as many African Nations, which in 1969, after the May 13<sup>th</sup> Race riots was written of as another "basket case" economy & what it is today, would make an ideal case study.)

Slide 41

The objective of this ONE FULL DAY SESSION WITH Q&A, will be :

To help leaders who are making decisions about the future of their nation in a rapidly changing and competitive world to **understand the Economic Process that drives Nation Building and the challenges of Globalization.**

Slide 42

The session will help in some degree to make all Members of Parliament and Political Leaders realize:



- # The critical role that FDIs can play in the process of Jobs and Wealth creation.
- # That PROFITS should not be a bad word.
- # What must be done to attract the FDI that can help achieve economic success?
- # And that every Ministry, every Dept. is part of the economic process of nation building.

Slide 43

**2) The 2<sup>nd</sup> side of the Triangle of Hope relates to "Civil Service efficiency and integrity"!**

- For Civil Servants, which will include all officers in the Investment Promotion Center and two or three TOP OFFICIALS from every Govt. Dept. involved in the Economic Process ( Customs, Immigration, Road Transport, Central Bank, Ministry of Finance etc)...a full 2 ½ to 3 day Capacity Building/Training session can be held.
- The title of the topic can be same as that for the MPs, but this Training session will go into depth on issues of coordination, streamlining etc.

Slide 44

**In short whereas the MPs session will focus on WHAT should be done to achieve Economic Success, the Civil Servants session will address not just the WHAT but HOW it can be done.**

- The lessons from Asia regarding streamlining & capacity building can be useful.
- The setting up of INTEGRATED APPROVAL SYSTEMS for every Govt. Dept., the streamlining of the approval mechanism at every level of the APPROVAL PROCESS from National/Central Govt. to Municipality/City levels will be critical.
- The process must move from KNOW WHO to get an approval, to KNOW HOW and the strength of the project itself.
- There must evolve a Systems Approach in Govt. and one way would be to embrace "e governance" as a concept to drive efficiency and to reduce Red Tape and corruption.

Slide 45

**Integrated Approval Systems**

- Who are you serving?
- Why?
- Is the service you provide most efficient?
- How to improve further?
- Is your internal system fully integrated – (How can further integration be achieved).
- Are you integrated with other Department?
- Do you think that the service your Department provides has a role in Jobs & Wealth creation and Poverty Eradication?
- What is it's role and how can maximum efficiency & productivity be achieved?

Slide 46

9) Which Government Departments do you think you are related to

(a) Directly (b) Indirectly

- Do you know that a chain is only as strong as its 'weakest' link?
- In the chain of National Economic Development is your Department – a strong or weak link?
- How to strengthen that link?
- Do you know that though the chain is as strong as its 'weakest' link – that the Department Head is the link maker, the Minister & the Civil Service Head of Ministry make part of the chain and that the Head of State is the ultimate Chain maker?
- How can you help the Minister and Head of State to create an unbreakable chain?

Slide 47

**(3) The 3rd Force in the Triangle of Hope is PRIVATE SECTOR DYNAMISM and INTEGRITY:-**

- Here it is proposed that a ONE Day briefing session be held for all the Captains of Industry on the similar basis as that of the MPs.
- The Topic title can remain:
- STRATEGIC ACTION INITIATIVES FOR ECONOMIC DEVELOPMENT AND THE ASIAN EXPERIENCE**
- In addition the presentation could include issues relating to GLOBALIZATION, and some suggestions as to what the private sector can do to be prepared for these challenges.

Slide 48

**In respect of the Quadrant Strategy that encompasses INVESTMENT ENVIRONMENT, PROJECTS, PROMOTION AND IMPLEMENTATION interested African Governments can be helped to:**

- 1) Examine & assisted as to how the Investment Environment can be improved to attract FDI and to stimulate domestic investments.
- 2) Identify strategic Industries/Projects that can be promoted to maximize the competitive advantage that a country has to offer.
- 3) Launch Investment Promotion strategies/ programmes in target Asian CAPTEN Nations.
- 4) Ensure that that proper mechanisms are in place to ensure speedy Implementation of approved projects.

Slide 49

In addition to the above in a programme called "Agenda of Action", the following should be undertaken:

- 1) To create a "FAMILIARITY THAT WILL BREED CONFIDENCE" among Asian Businessmen, interested African Governments should consider the following actions:
  - a) Organize with African private sector, buying and selling missions to target Asian nations.

This will create direct linkages between Asian and African Businessmen, reduce the role of the middle man from other nations and reduce the cost of Asian products in Africa.

Such increased business linkages will create the confidence for longer term Asian investments.

Slide 50

b) Offer to Asian businessmen, opportunities to participate in the

**"Privatization and Development Projects (PDPs) the country has to offer."**

- To implement this, the relevant African Governments should put together a package of PDPs and organize missions to target Asian nations.

Slide 51

c) Promote Asian Financial Institutions (Banks & Insurance) to set up operations, for these are the most powerful conduits for flow of Investment funds.

Slide 52

To ensure that the existing domestic & foreign private sector are an ally to Government's Promotion efforts, African Govts. can be helped to set up "Public-Private Sector Presidential Committees on Investments." ( PPS-PCI)

**OBJECTIVE:** To create a happy , supportive, domestic Private Sector Group.

- 1) The President with Key Economic Ministers and Captains of Industry should meet, initially at least 2 or 3 times a year, and later as issues are addressed and solved these can be reduced to an Annual basis.
- 2) The issue of meetings is not just to call a meeting and having it end as a "complaints session". The sessions should have considerable pre planning and preparations so that the Presidential meeting becomes highly productive.

The Asian Experience as to how these PPS -PCIs can be set up to become powerful tools for Investments, can be shared.

Slide 53

**Key Question: Do African Govts. feel that they want to proceed on sustained, well planned strategies?**

Also are International & National Donor Agencies prepared for such strategic steps that are sustained and results not as "Reports on a dust covered shelves", but "Jobs and Wealth" on the Ground.

I have worked with many International Agencies since I retired from MIDA in 1999. All are sincere, but how many have gone beyond "Reports that end up on shelves"?

Slide 54

**Proposal for 3 Testbed Nations (The TRIDENT STRATEGY)**

- Despite millions of dollars being poured into Africa, there is not one Economic Model that can be taken as a Success Story that others can emulate, unlike the multiple success stories in Asia, from Japan to Singapore, from Taiwan and South Korea to Thailand and Malaysia.

Slide 55

- I had suggested to many International Agencies, that whereas all nations be helped, 3 TESTBED Nations be selected to launch the full 3 to 5 year "S.A.I. for Economic Development" programme and that we work with these 3 Nations until we see Jobs and Wealth on the ground.

Slide 56

The proposal was that 3 "Test Bed Models" be selected:

- (a) A Land Locked Nation (e.g. Uganda, Zimbabwe, Malawi, Rwanda, Zambia etc)
- (b) A Nation with Coastline and a relatively large population.
- (c) An Island Economy.

I am proud to say that the Japanese Govt. through JICA accepted this challenge

Slide 57

### The 1<sup>st</sup> Test Bed Nation is Zambia: Land Locked.

- 1) An MOU was signed between JICA and the Govt. of Zambia in March 2005 to launch what is now known in Zambia as the "Triangle of Hope" programme.
- 2) The Political Will has been tremendous:
  - The President has formed a Presidential Steering Committee chaired by the Deputy Secretary to the Cabinet and where the JICA Resident Representative is one of the 2 Deputy Chairmen.

Slide 58

- 3) Arrangements were made for the JICA consultant to brief Parliament and this briefing was well received by all parliamentarians.
- 4) The President has shown personal interest and he and his cabinet has been briefed on 3 occasions on the progress of the TOH agenda.
- 5) In keeping with the TOH formula the Govt. arranged a 3 day Briefing cum Workshop session on the TOH programme for Senior Civil Servants and also a session with the Private sector.

Slide 59

- 6) After fulfilling the obligations of the TOH the GoZ proceeded to fulfill the requirements of the Quadrant Strategy viz: Environment, Projects, Promotion & Implementation.
- 7) 12 Govt. Private sector Task Forces were set up to look at issues relating to the Physical and Administrative Infrastructure, (Environment & Implementation), and Sectors that will have Competitive Advantage (Projects)
- 8) The Task Forces were given a TOR and were briefed on expectations and given 3 months to present their reports.
  - This they did very effectively. All TF recommendations were submitted to Cabinet and have been approved.

Slide 60

- 9) The GOZ, with JICA's assistance where necessary, is now involved in the Implementation of all Recommendations approved by Cabinet. A monitoring mechanism has been established and JICA is helping in this process.
- 10) Having fulfilled to an extent the expectations of the Quadrant strategy we are now entering the Promotion phase.
- 11) Project Profiles are being drawn up, initially focusing on existing companies that wish to expand, diversify or set up new projects. An Investment Booklet designed with the Potential Investor in mind is being prepared.

Slide 61

- 12) A very focused Investment Seminar is being organized in Malaysia towards the end of Nov. 2006 and in March 2007 we are planning for a Malaysian Investment Mission to Zambia.
- 13) Since this is a Asia – Zambia South South Initiative, the promotion initiatives to other Nations in Asia will commence in the 2<sup>nd</sup> quarter of 2007.
- 14) It is the expectation, if all goes as planned and all recommendations of the TFs are fully implemented that Zambia should experience increased FDIs, increased JVs with Foreign Investors and increased Jobs and Wealth for the people of Zambia, in the next 2 to 3 years.

Slide 62

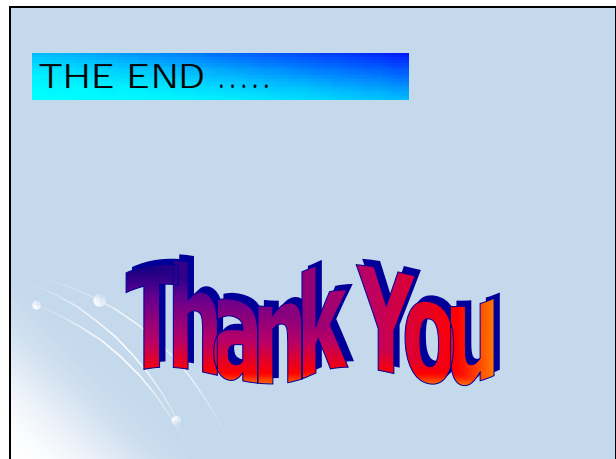

Slide 63

**@ Copyright**  
**JJ International Consultants**

■ **Dato' J. Jegathesan**  
No 24, Jalan Abdullah,  
off Jalan Bungsar,  
59000, Kuala Lumpur  
Malaysia.

E-mail:- [jjegaic@yahoo.com](mailto:jjegaic@yahoo.com)  
Website:- [www.jjegaic.com](http://www.jjegaic.com)

## **GRIPS DEVELOPMENT FORUM SEMINAR**

### **~East Asian Development Experience and the Role of Emerging Donor**

Comment by Aiichiro Yamamoto  
Senior Assistant to Director-General,  
Africa Department, JICA

#### **1. Asia-Africa Cooperation**

- Replication of Asian success model to Africa?
- Asia- Africa Knowledge Co-creation Programme

#### **2. Trade and Investment in the Current Globalised Economy**

- Changing world economic situations and the speed of globalisation.
- FDI is not the only solution across Africa.

#### **3. African Growth Challenge**

- Exogenous development v.s. endogenous development
- “One Village One Product” movement in Malawi.

*Success will not be brought in from outside. It will come from inside.*